

# Home Safety Self Assessment Tool (HSSAT) v.3

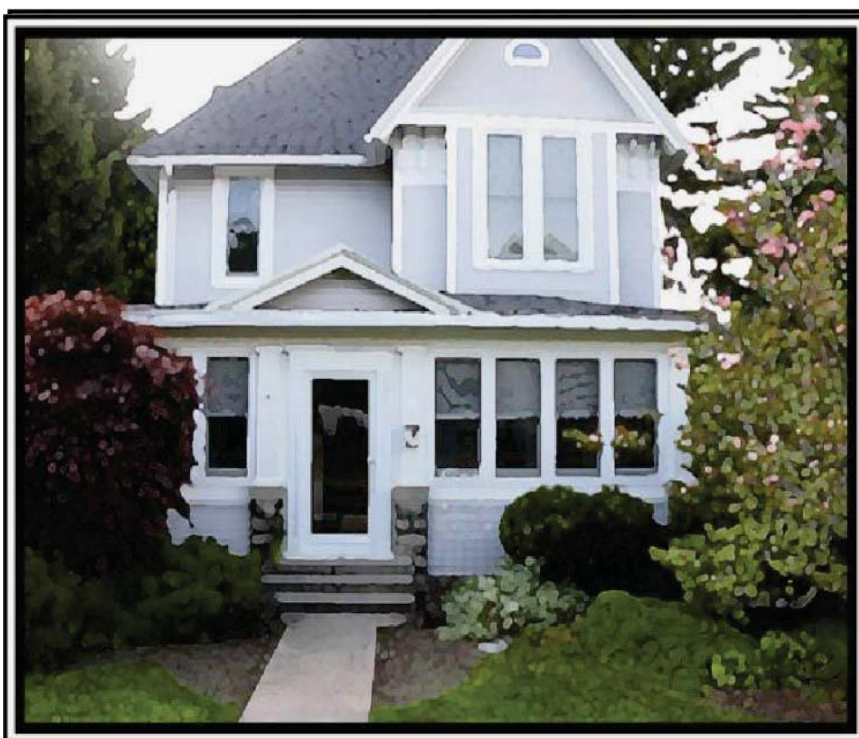

Occupational Therapy Geriatric Group  
Department of Rehabilitation Science  
University at Buffalo

**FallsPrevention**<sup>™</sup>  
STEP UP TO STOP FALLS

Supported by a grant from the Community Health Foundation of Western and Central New York

# HOME SAFETY SELF ASSESSMENT TOOL (HSSAT) v.3

Falls are the leading cause of injury, disability, nursing home placement, and death in adults over the age of 65 years. Yet in the United States one in every three older adults falls each year. In order to address this problem, the Occupational Therapy Geriatric Group at the University at Buffalo created the Home Safety Self Assessment Tool, as a part of combined effort with the Community Health Foundation of Western and Central New York to disseminate information regarding how to prevent falls in Erie County, NY. The HSSAT has been found to be useful in reducing the occurrence of falls at home through a study that was conducted at the Department of Rehabilitation Science, University at Buffalo. In Version 3, information on assistive devices and helpful products to prevent falls has been added to Home Safety Check List and Solution (V. 2). Use of this tool as instructed in this book helps to prevent future falls. An online version of this tool is available for download at [www.agingresearch.buffalo.edu](http://www.agingresearch.buffalo.edu).

The HSSAT (V.3) consists of six major sections:

1. **The Home Safety Self Assessment Checklist and Solutions**

Information on how to use this section can be found on page 3 of this manual.

2. **Assistive Devices and Helpful Products to Prevent Falls**

The products were selected based on their usability, quality, and rating by users.

The products are categorized to correspond with the Solutions on the Home Safety Checklist.

Picture credits for selected products are listed at the end of the Checklist on pages 31 and 32.

3. **Home Modification Services, Stores Carrying Durable Medical Equipment, and Organizations to Provide Free Services in Erie County**

This section lists service providers in Erie County who perform home modifications such as installing grab bars and railings or widening the doorway of a bathroom. They are insured and have experience in home modifications and remodeling and are willing to perform a small job at your home. Also listed are the stores that carry durable medical equipment and other products that are useful in preventing falls. Some stores do not have wheelchairs. Free services related to fall prevention in Erie County are also listed in this section. (Pages 34-38)

4. **Tips for Fall Prevention**

This one page list includes tips for fall prevention other than the risk factors discussed in the previous sections. (Page 33)

5. **ADA Instructions for Home Environment**

The Americans with Disabilities Act (ADA) sets guidelines for accessibility to public places and commercial facilities by individuals with disabilities. This is not applicable to single homes but may be applicable for commercial apartments. In this section, six guidelines are selected. (Pages 39-45)









6. **Action Log**

This section is provided to keep a record of your home hazard removal process. (Pages 46-47)

Machiko R. Tomita, Ph.D.  
March 1, 2011

Department of Rehabilitation Science  
University at Buffalo, State University of New York

# TABLE OF CONTENTS

<b><u>Instructions for How to Use HSSAT Checklist</u></b>	<b>3</b>
<b>Home Safety Checklist and Solutions</b>	
<b> <u>Entrance to Front Door and Front Yard</u></b>	<b>4-5</b>
<b> <u>Entrance to Back/Side Door</u></b>	<b>6-7</b>
<b> <u>Hallway or Foyer</u></b>	<b>8-9</b>
<b> <u>Living Room</u></b>	<b>10-11</b>
<b> <u>Kitchen</u></b>	<b>12-13</b>
<b> <u>Bedroom</u></b>	<b>14-15</b>
<b> <u>Bathroom</u></b>	<b>16-17</b>
<b> <u>Staircases</u></b>	<b>18-19</b>
<b> <u>Laundry Room/Basement</u></b>	<b>20-21</b>
<b><u>Assistive Devices and Helpful Products to Prevent Falls</u></b>	<b>22-29</b>
<b><u>Total Number of Home Hazards</u></b>	<b>30</b>
<b><u>Picture Credits for Assistive Devices and Helpful Products</u></b>	<b>31-32</b>
<b><u>Tips for Fall Prevention</u></b>	<b>33</b>
<b><u>Home Improvement Centers and Durable Medical Equipment Providers in Erie County</u></b>	<b>34</b>
<b><u>Home Modification Service Providers in Erie County</u></b>	<b>35-36</b>
<b><u>Organizations That Provide Free Services in Erie County</u></b>	<b>37-38</b>
<b><u>Instruction for Home Modifications to Prevent Falls: ADA Guideline</u></b>	<b>39-45</b>
<b><u>Action Log</u></b>	<b>46-47</b>
<b><u>Acknowledgement and Contact Information</u></b>	<b>48</b>

# **HOW TO USE HSSAT CHECKLIST TO IDENTIFY HOME HAZARDS TO PREVENT FALLS**

Use the checklist to find and correct/fix the hazards for every room/area in your home that could cause you to trip or fall. All items are potential risks for falls but if a wheelchair is not used, some items may not apply.

## **Steps to use the checklist**

### **Step 1:**

Go to each room/area of your home with this checklist. Look for the hazards/items that are listed below the picture on each page (Some items may not relate to your home).

### **Step 2:**

If the problem is present in your room/area, check off in the appropriate box. After checking all of the problems, add them up and write the total in the big box. (Each item that gets a checkmark is a potential hazard).

### **Step 3:**

Then go through the solutions and take the necessary action to fix those problems that are a potential hazard. Make sure that you look at assistive devices and helpful products that are indicated in the solutions section. Having them can make your home safer.

### **Step 4:**

Add the total number of hazards in all the rooms/areas to get a grand total.

### **Step 5:**

Write down what action you are planning to take and have already taken to prevent falls in the Action Log for your records.

### **Step 6:**

It may be a good idea for you to ask your family and friends for a home safety modification and assistive device for your birthday or holiday present. Also talk with your friends about home safety. It can be a great gift for them to know how to prevent future falls.

## Entrance to Front Door and Front Yard

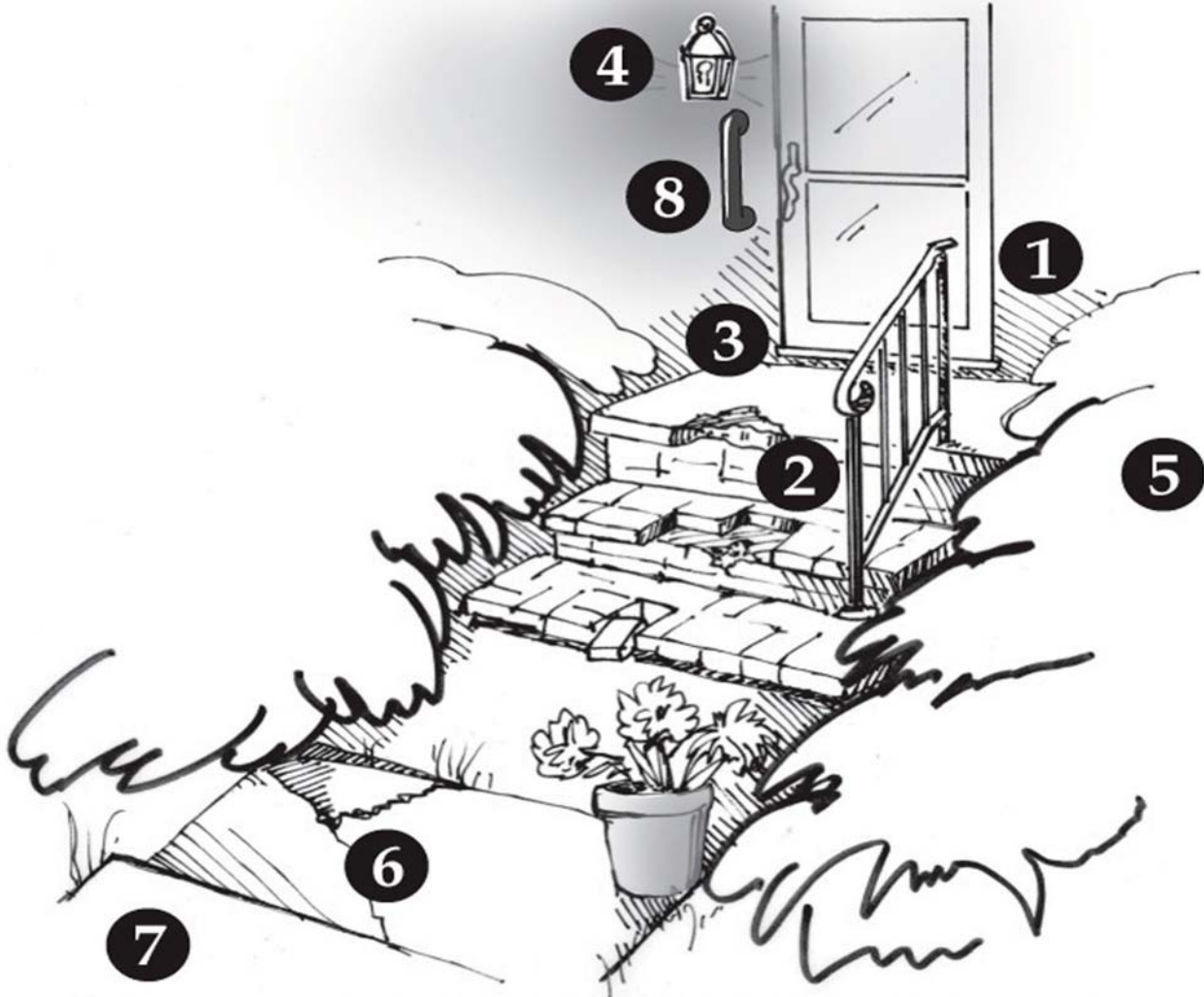

The list identifies all of the potential home hazards that may cause a fall. If the item applies to your home, place a check in the box. Then add the total number of checks and enter it in the box below.

1. Lack of railings or unstable railing

5. Lack of a ramp for a wheelchair

2. Unsafe steps (too steep/cracked)

6. Uneven/cracked pavement

3. Unmarked or raised threshold

7. Ice or snow on driveway/walkway

4. Lack of lighting at night

8. Lack of an outdoor grab bar

Other \_\_\_\_\_

Total number of problems

\* The numbers correspond to the hazard in the picture and solutions on the following page

## **Solutions for the Problems in Entrance to Front Door and Front Yard**

### **1. Lack of railings or unstable railing**

Add at least one railing, ideally one on each wall. (See page 22, item 1)  
Have unstable railing stabilized.

### **2. Unsafe steps (too steep, cracked, chipped, etc.)**

Have damaged or broken steps repaired.

### **3. Unmarked or raised threshold**

Mark end of steps or thresholds with contrasting tape or paint color to increase awareness of change in height. (See page 22, item 2)

### **4. Lack of lighting at night**

Add an outdoor light fixture.  
Add a sensor light that automatically turns on and off. (See page 22, item 3)

### **5. Lack of a ramp for a wheelchair**

Have a remodeler or home contractor construct a ramp that will allow wheelchair access in and out of the home. (See page 23, item 4)

### **6. Unsafe pavement (uneven or cracked)**

Have uneven or cracked pavement repaired.  
Avoid these areas if possible when walking to and from the home.  
You may contact local government for repair if it is a sidewalk or driveway end.

### **7. Ice or snow on driveway or walkway**

Use snow melter.  
Have snow/ice removed by a neighbor or service. (See page 23, item 5)

### **8. Lack of an outdoor grab bar**

Add an outdoor grab bar next to the door. (See page 23, item 6)

**For information on an additional device, see page 29, item 31.**



## Entrance to Back/Side Door

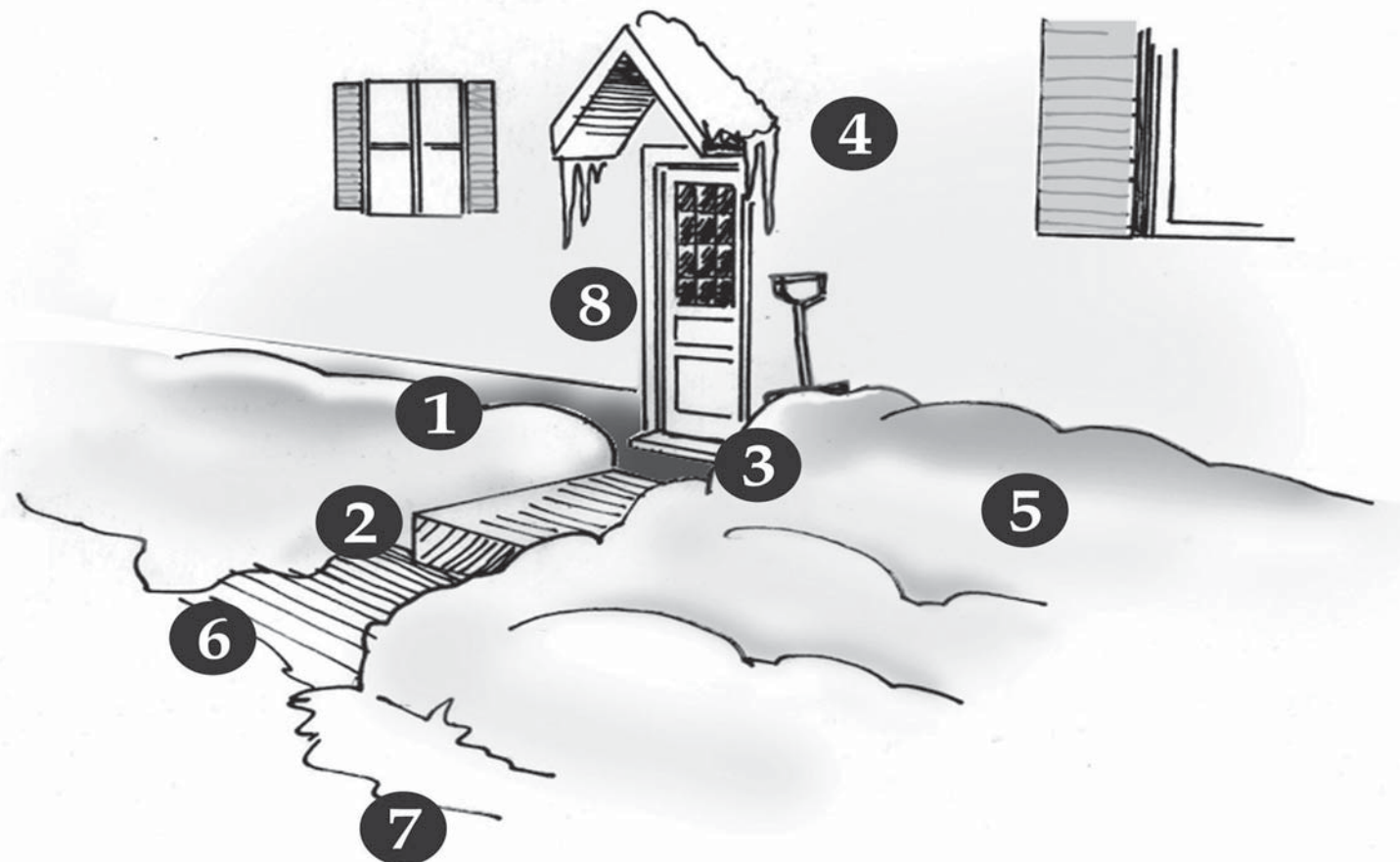

The list identifies all of the potential home hazards that may cause a fall. If the item applies to your home, place a check in the box. Then add the total number of checks and enter it in the box below.

- |   |   |
|---|---|
| <input type="checkbox"/> 1. Lack of railings or unstable railing<br><input type="checkbox"/> 2. Unsafe steps (too steep/cracked/chipped)<br><input type="checkbox"/> 3. Unmarked or raised threshold<br><input type="checkbox"/> 4. Lack of lighting at night | <input type="checkbox"/> 5. Lack of a ramp for a wheelchair<br><input type="checkbox"/> 6. Uneven/cracked pavement<br><input type="checkbox"/> 7. Ice or snow on walkway<br><input type="checkbox"/> 8. Lack of an outdoor grab bar |
|---|---|

Other \_\_\_\_\_

Total number of problems

\* The numbers correspond to the hazard in the picture and solutions on the following page

## **Solutions for the Problems** **Entrance to Back/Side Door**

### **1. Lack of railings or unstable railing**

Add at least one railing, ideally one on each wall. **(See page 22, item 1)**  
Have unstable railing stabilized.

### **2. Unsafe steps (too steep, cracked, chipped, etc.)**

Have damaged or broken steps repaired.

### **3. Unmarked or raised threshold**

Mark end of steps or thresholds with contrasting tape or paint color to increase awareness of change in height. **(See page 22, item 2)**

### **4. Lack of lighting at night**

Add an outdoor light fixture.  
Add a sensor light that automatically turns on and off. **(See page 22, item 3)**

### **5. Lack of a ramp for a wheelchair**

Have a remodeler or home contractor construct a ramp that will allow wheelchair access in and out of the home. **(See page 23, item 4)**

### **6. Unsafe pavement (uneven or cracked)**

Have uneven or cracked pavement repaired.  
Avoid these areas if possible when walking to and from the home.  
Contact local government for repair if it is a sidewalk or driveway end.

### **7. Ice or snow on walkway**

Use snow melter.  
Have snow/ice removed by a neighbor or service. **(See page 23, item 5)**

### **8. Lack of a outdoor grab bar**

Add grab bar next to the door. **(See page 23, item 6)**



## Hallway or Foyer

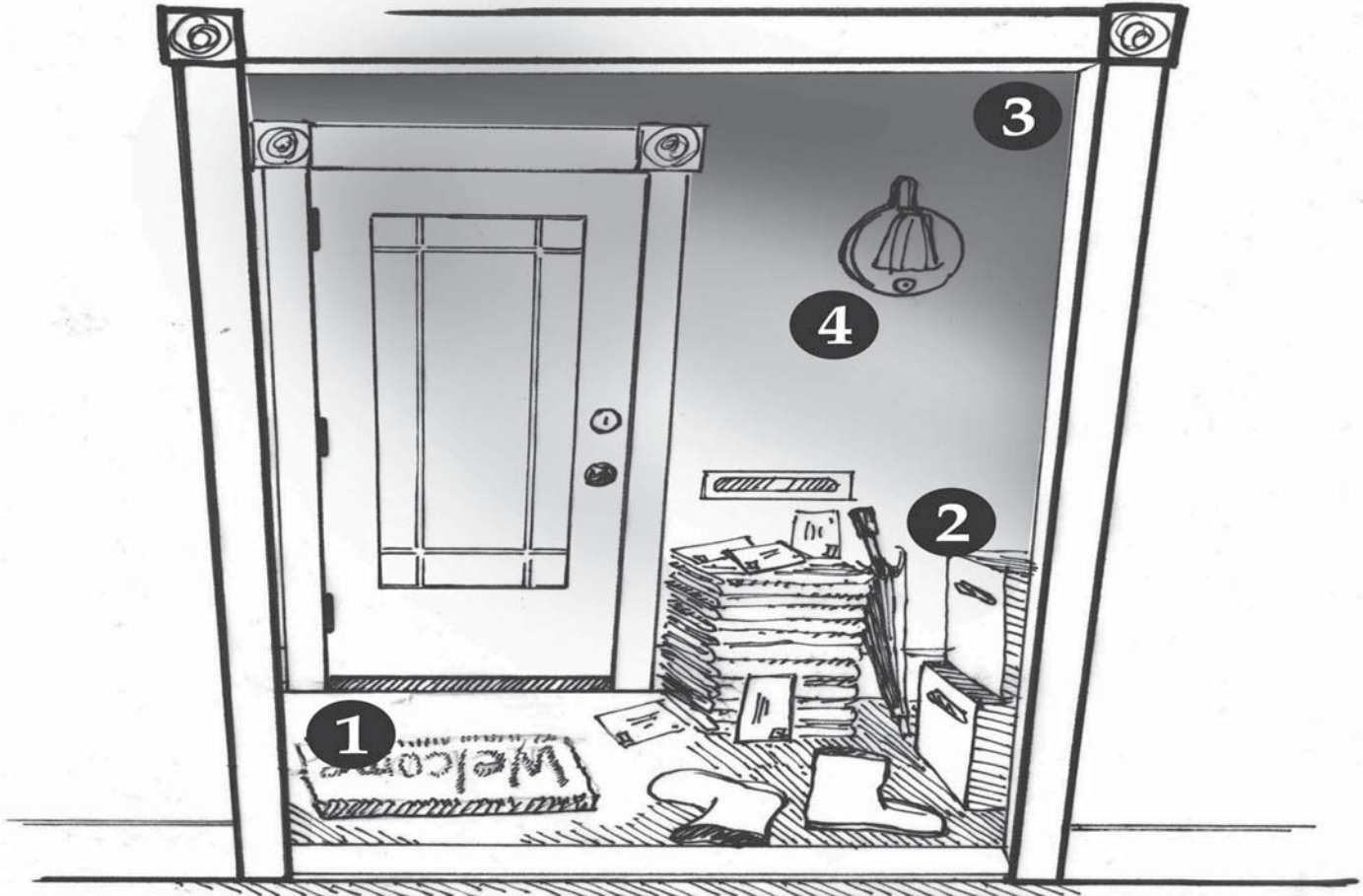

The list identifies all of the potential home hazards that may cause a fall. If the item applies to your home, place a check in the box. Then add the total number of checks and enter it in the box below.

1. Uneven or slippery flooring

3. Dark or poor lighting

2. Cluttered area

4. Lack of access to ceiling light

Other \_\_\_\_\_

Total number of problems

\* The numbers correspond to the hazard in the picture and solutions on the following page

## **Solutions for the Problems** **in Hallway or Foyer**

### **1. Unsafe flooring (slippery, uneven carpeting, etc.)**

Make sure floor surfaces are dry.

If you have a carpet, make sure that the patterns are not too busy.

Have carpet stretched or removed to eliminate wrinkles or bumps.

Add a carpet runner to slippery hallway or foyer and secure to the floor.

**(See page 26, item 17)**

### **2. Cluttered area**

Eliminate clutter on floors by removing and/or organizing items.

Example: shoe tray, hooks for umbrella.

### **3. Dark or poor lighting**

Increase wattage to allowable limits in lights.

Add additional overhead or wall lighting.

### **4. Lack of access to ceiling light**

Ask another person to change the light.

Add removable wall lights to poorly lit areas. **(See page 23, item 7)**

## Living Room

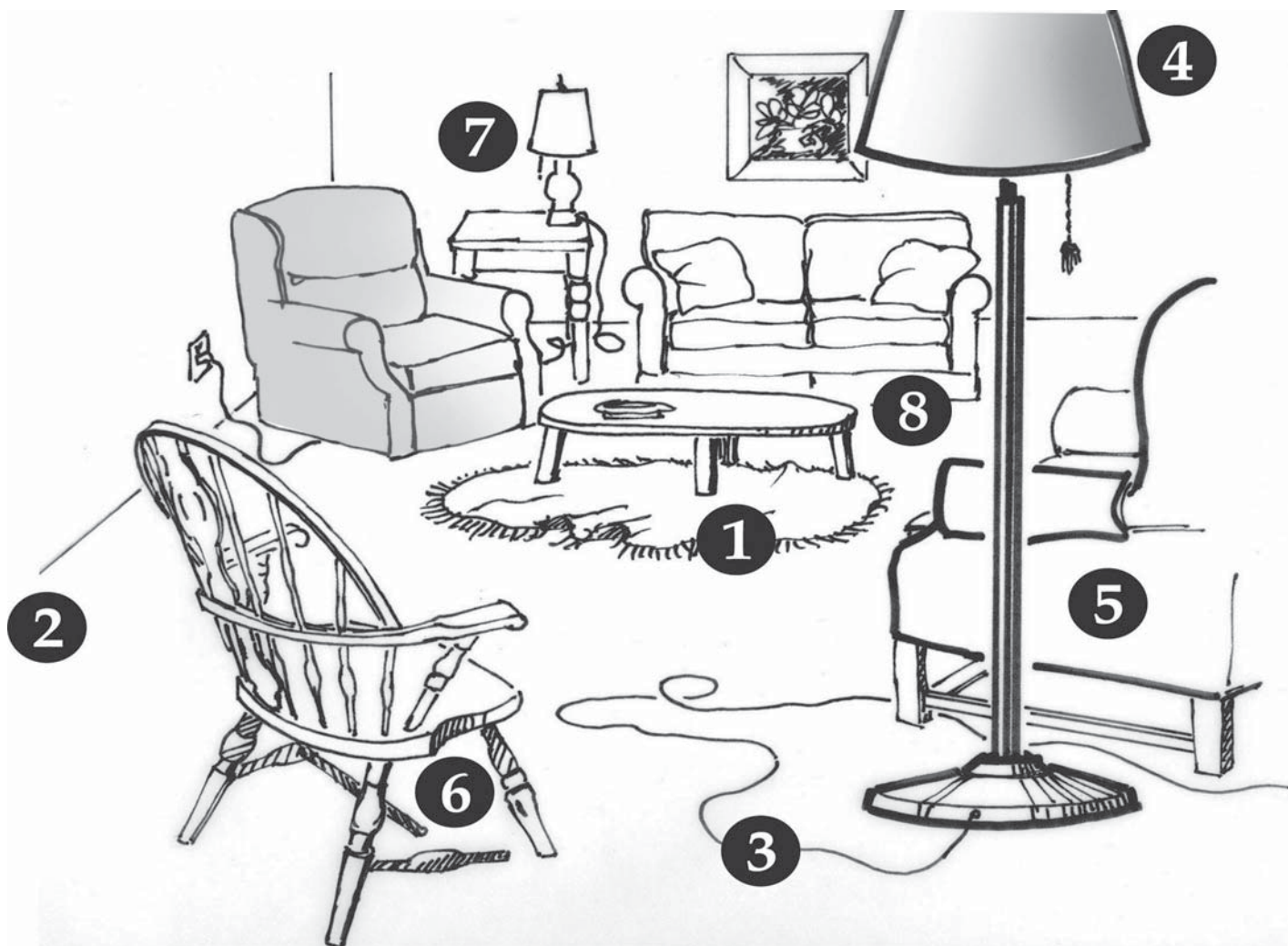

The list identifies all of the potential home hazards that may cause a fall. If the item applies to your home, place a check in the box. Then add the total number of checks and enter it in the box below.

1. Presence of throw or scatter rug

5. Presence of unstable furniture

2. Presence of clutter

6. Presence of unstable chair

3. Presence of electric cords across the floor

7. Difficult to access light switches

4. Poor lighting

8. Not enough space to move around

Other \_\_\_\_\_

Total number of problems

\* The numbers correspond to the hazard in the picture and solutions on the following page.

## **Solutions for the Problems in Living Room**

### **1. Presence of throw or scatter rug (See page 24, item 8)**

Remove a scatter rug or use double-sided rug tape or a rug pad to secure the rug to floor.

### **2. Presence of clutter**

Eliminate clutter on floor surfaces by placing items on shelves or in storage. Consider donating or throwing out the items you no longer use. Avoid carpets with confusing patterns.

### **3. Presence of electric cords across the floor**

Run your cords behind furnishings. Use extension cords to accomplish this. Rearrange items that must be plugged in to areas near an outlet. **(See page 24, item 9)**

### **4. Poor lighting**

Increase wattage to allowable limits in lamps/lights. Add additional lamps or wall/overhead lights.

### **5. Presence of unstable furniture (chair, table, etc.)**

Place a block under the shorter leg. If the chair or table is broken, have it repaired or replaced.

### **6. Presence of unsafe chair (too low, too high, without arms)**

If the chair is too low, add a furniture leg riser to raise the height. A chair that is too high or without arms should not be used, as it will not provide you with sufficient stability to get in and out of the chair. **(See page 24, item 10)**

### **7. Difficult to access light switches**

Add "clapper" light switch control to lamps. There are other remote control switching options for operating the lights. Rearrange furnishings to allow quick access to wall switch or lamps.

### **8. Not enough space to move around**

Remove clutter or excess furniture that prevents you from moving around the room easily. Some items may be rearranged, but you may want to donate or throw out other items you don't really need or use.

**For information on an additional device, see page 24, item 11**

## Kitchen

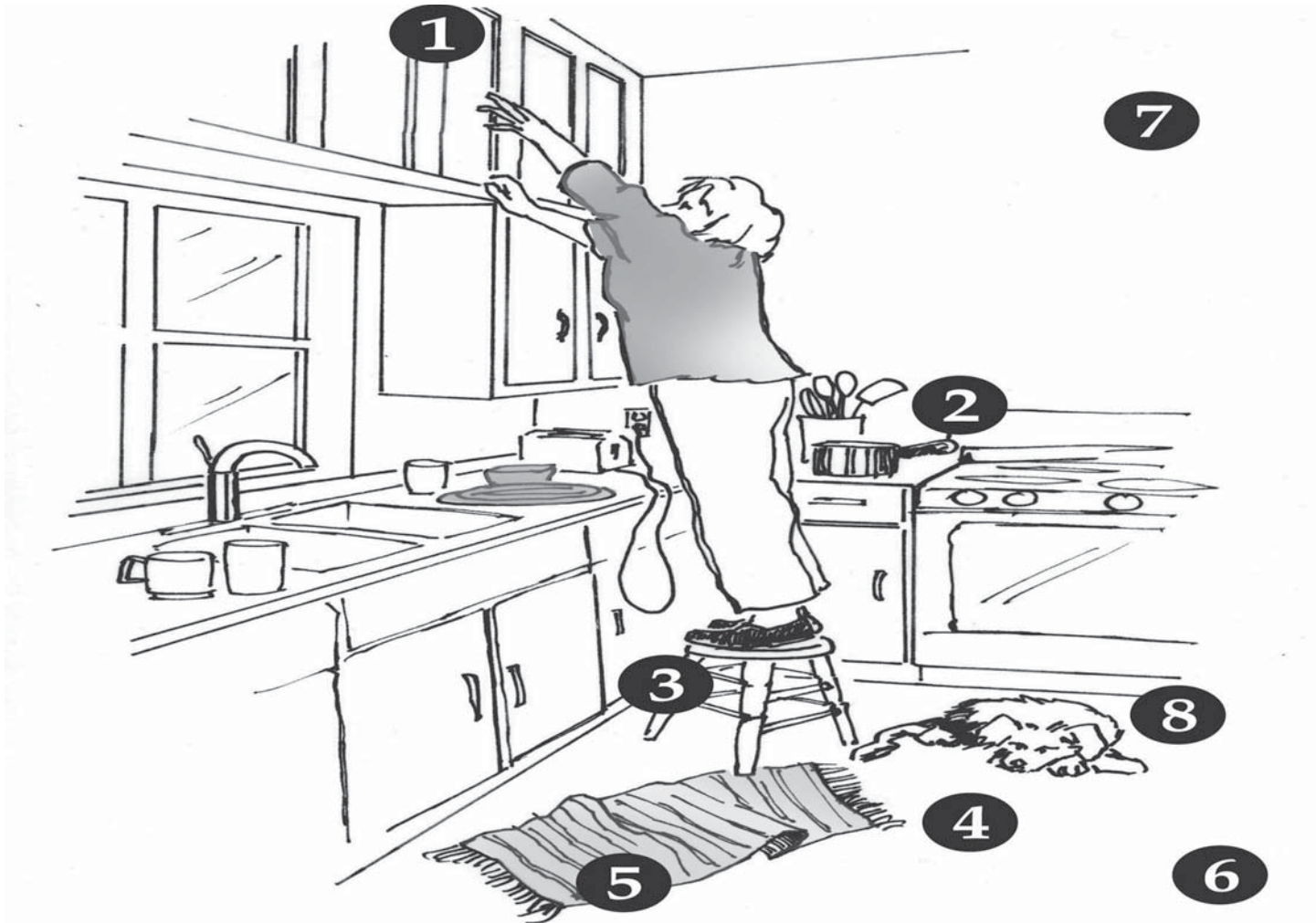

The list identifies all of the potential home hazards that may cause a fall. If the item applies to your home, place a check in the box. Then add the total number of checks and enter it in the box below.

- |  |   |
|--|---|
| <input type="checkbox"/> 1. Cabinet too high or low<br><input type="checkbox"/> 2. Not enough counter space<br><input type="checkbox"/> 3. Using a stool or a chair to reach things<br><input type="checkbox"/> 4. Not enough room to maneuver | <input type="checkbox"/> 5. Presence of throw/ scatter rug<br><input type="checkbox"/> 6. Slippery floor<br><input type="checkbox"/> 7. Poor lighting<br><input type="checkbox"/> 8. Presence of a pet underfoot when preparing meals |
|--|---|

Other \_\_\_\_\_

Total number of problems

\* The numbers correspond to the hazard in the picture and solutions on the following page



## **Solutions for the Problems in Kitchen**

### **1. Cabinet too high or too low**

Move items to the shelves closest to the counter.  
Add hooks to the wall for pots and pans you use frequently.

### **2. Not enough counter space**

Make sure available counter space is cleared of clutter. Use Lazy Susan.  
**(See page 25, item 14)**  
Move kitchen table closer to counter for additional work space.  
Use a rolling cart for added work space.

### **3. Using a stool or a chair to reach things**

Move items to lower shelves.  
Replace the stool with a sturdy step ladder. **(See page 25, item 12)**

### **4. Not enough room to maneuver**

Eliminate clutter or excessive furniture (extra kitchen chairs, etc.) to add space.  
Remove a leaf from the table and push it closer to the wall.

### **5. Presence of a throw/scatter rug**

Remove a scatter rug or use double-sided rug tape or a rug pad to secure the rug to floor. **(See page 24, item 8)**

### **6. Slippery floor**

Do not walk on a wet floor.  
Wear comfortable shoes that fit well or socks with a non-skid sole.  
**(See page 25, item 13)**  
Change flooring surface to one that is less slippery.

### **7. Poor lighting**

Increase wattage of bulbs to allowable level.  
Add under counter lighting.  
Add additional overhead lighting.

### **8. Presence of a pet underfoot when preparing meals**

Remove the pet from the kitchen while cooking and add a pet gate to the entry ways of the kitchen. **(See page 25, item 15)**  
Put the pet outside or in a crate.

**For information on an additional device, See page 26, item 16**



## Bedroom

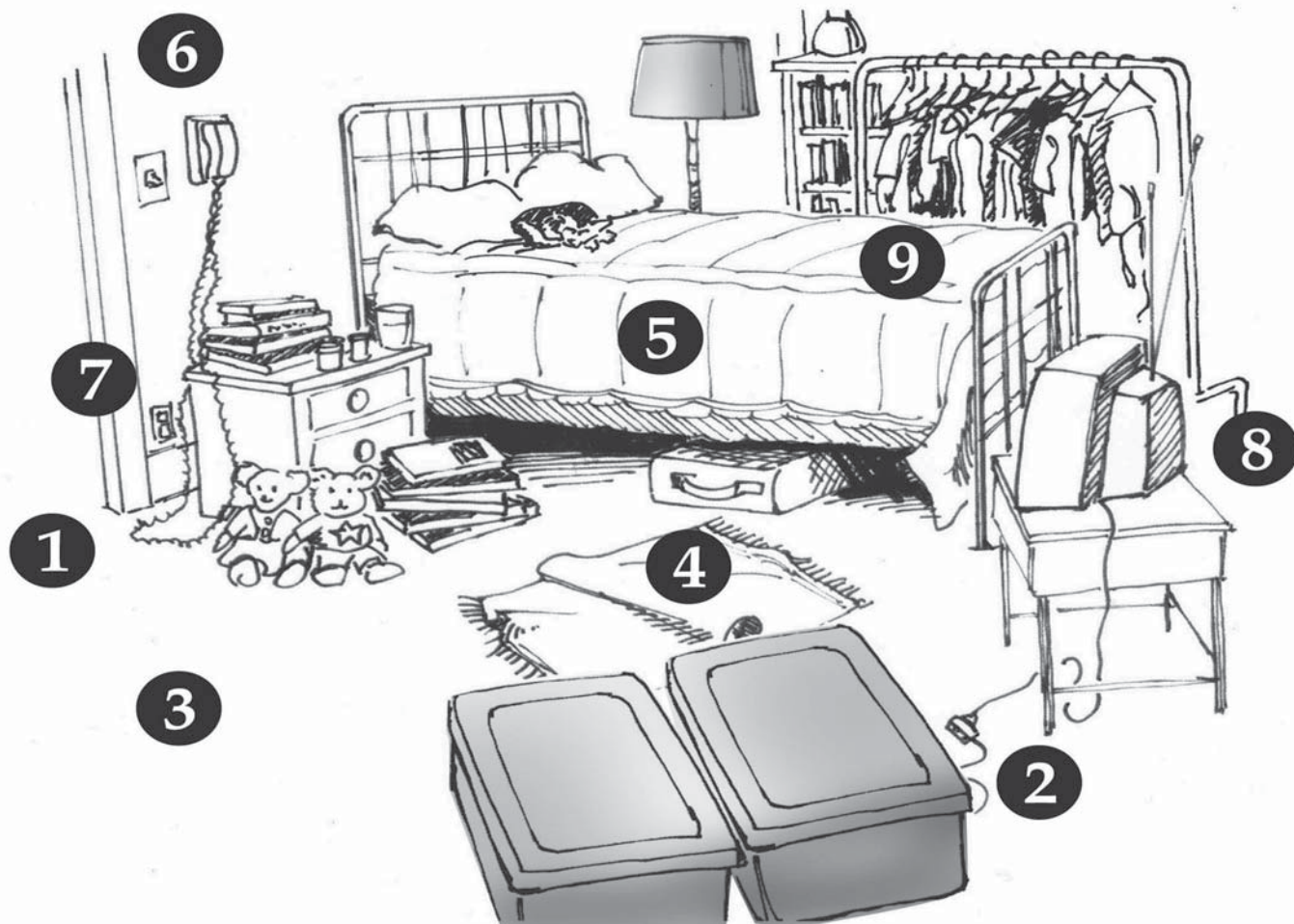

The list identifies all of the potential home hazards that may cause a fall. If the item applies to your home, place a check in the box. Then add the total number of checks and enter it in the box below.

- |  |  |
|--|--|
| <input type="checkbox"/> 1. Presence of clutter<br><input type="checkbox"/> 2. Presence of electric cords across the floor<br><input type="checkbox"/> 3. Unsafe carpet (uneven, torn, curled up)<br><input type="checkbox"/> 4. Presence of throw/scatter rug<br><input type="checkbox"/> 5. Height of bed (too low/high) | <input type="checkbox"/> 6. Lack of a telephone near the bed<br><input type="checkbox"/> 7. Lack of nightlight<br><input type="checkbox"/> 8. Arrangement that causes difficulty to reach items (TV remote, lamp)<br><input type="checkbox"/> 9. Lack of device to get in/out of bed |
|--|--|

Other \_\_\_\_\_

Total number of problems

\* The numbers correspond to the hazard in the picture and solutions on the following page

## **Solutions for the Problems In Bedroom**

### **1. Presence of clutter**

Eliminate clutter on floor surfaces by placing items on shelves or in storage. Consider donating or throwing out the items you no longer use.

### **2. Presence of electric cords across the floor (See page 24, item 9)**

Run your cords behind furnishings. Use extension cords to accomplish this. Rearrange items that must be plugged in to areas near an outlet.

### **3. Unsafe carpet (uneven, torn, curled up, etc.) (See page 26, item 17)**

Have carpet stretched or removed to eliminate wrinkles or bumps.

### **4. Presence of throw/scatter rug (See page 24, item 8)**

Remove all scatter and throw rugs or use double-sided rug tape or a rug pad to secure the rug to floor.

### **5. Height of bed (too high or low) (See page 24, item 10)**

Too low (your knees are above your hips when sitting on the edge of the bed) : Use bed risers under bed legs to raise height.

Too high (your legs do not touch the floor when sitting at the edge of the bed): Remove bed frame or use a lower profile mattress or box spring.

### **6. Lack of a telephone near the bed (See page 26, item 18)**

Place a cordless phone or cell phone next to your bed at night or during naps. Use a remote control for TV and VCR. (See page 26, item 19)

### **7. Lack of a nightlight (See page 23, item 7)**

Place at least two nightlights in the bedroom to illuminate the room at night. Add additional nightlights along the hall or path to the bathroom. Also add one nightlight in the bathroom.

### **8. Arrangement that causes difficulty to reach commonly used items such as a TV remote, medications, lamp, glasses, magnifier, etc. at night**

Place these items on your bedside table. If you don't have a table, you may put a rolling cart or shelving unit next to the bed.

### **9. Lack of a device to help getting in and out of the bed (See page 27, item 20)**

Purchase a half bedrail or a bed cane that can slide between mattress and box spring.

## Bathroom



The list identifies all of the potential home hazards that may cause a fall. If the item applies to your home, place a check in the box. Then add the total number of checks and enter it in the box below

- |  |  |
|--|--|
| <input type="checkbox"/> 1. Presence of unsafe bath rugs         | <input type="checkbox"/> 6. Slippery tub (lack of bath mat, etc)       |
| <input type="checkbox"/> 2. Lack of grab bars in the tub         | <input type="checkbox"/> 7. Claw foot/tub that is too high to get into |
| <input type="checkbox"/> 3. Lack of grab bars in the shower area | <input type="checkbox"/> 8. Lack of bath chair in the shower area      |
| <input type="checkbox"/> 4. Lack of grab bars near the toilet    | <input type="checkbox"/> 9. Clutter                                    |
| <input type="checkbox"/> 5. Toilet is too high or low            | <input type="checkbox"/> 10. Incorrect placement of grab bars          |

Other \_\_\_\_\_

Total number of problems

\* The numbers correspond to the hazard in the picture and solutions on the following page

## **Solutions for the Problems in Bathroom**

### **1. Presence of unsafe bath rugs.**

Use a bath rug with non-skid bottom.

### **2. Lack of grab bars in the tub (See page 27, item 21)**

Add a bath grab bar on the wall or a clamp-on grab bar to the tub.

### **3. Lack of grab bars in the shower area**

Add grab bars to the wall near the shower and on the wall where the bath faucets are.

### **4. Lack of grab bars near the toilet (See page 27, item 22)**

Add a grab bar on the level next to the toilet or toilet safety grab bars that attach at the toilet seat screws.

### **5. Toilet is too high or too low (See page 27, item 23)**

Add a raised toilet seat for seats that are too low.  
Consider a lower profile toilet if it is too high.

### **6. Slippery tub (lack of bath mat, etc.) (See page 28, item 24)**

Add a rubber bath mat or adhesive non-skid decals to the bottom of the tub.

### **7. Claw foot or other type of tub that is too high to get into easily**

Add a tub transfer bench to slide into the tub area or replace with a lower tub.

### **8. Lack of bath chair or tub transfer bench in the tub or shower area**

Add a bath chair along with grab bars to the tub or shower area. A tub transfer bench is helpful if you have difficulty stepping into the tub area, because you can sit and slide over into the tub area.

### **9. Clutter**

Remove clutter from all floor areas. Inexpensive plastic cabinets or rolling units can be purchased to store bath items.

### **10. Incorrect placement of grab bars**

If permanently installed, hire a qualified professional to change the grab bars to the correct location and angle.

**\* See page 28, items 25 & 26 and page 29, item 31**

## Staircases

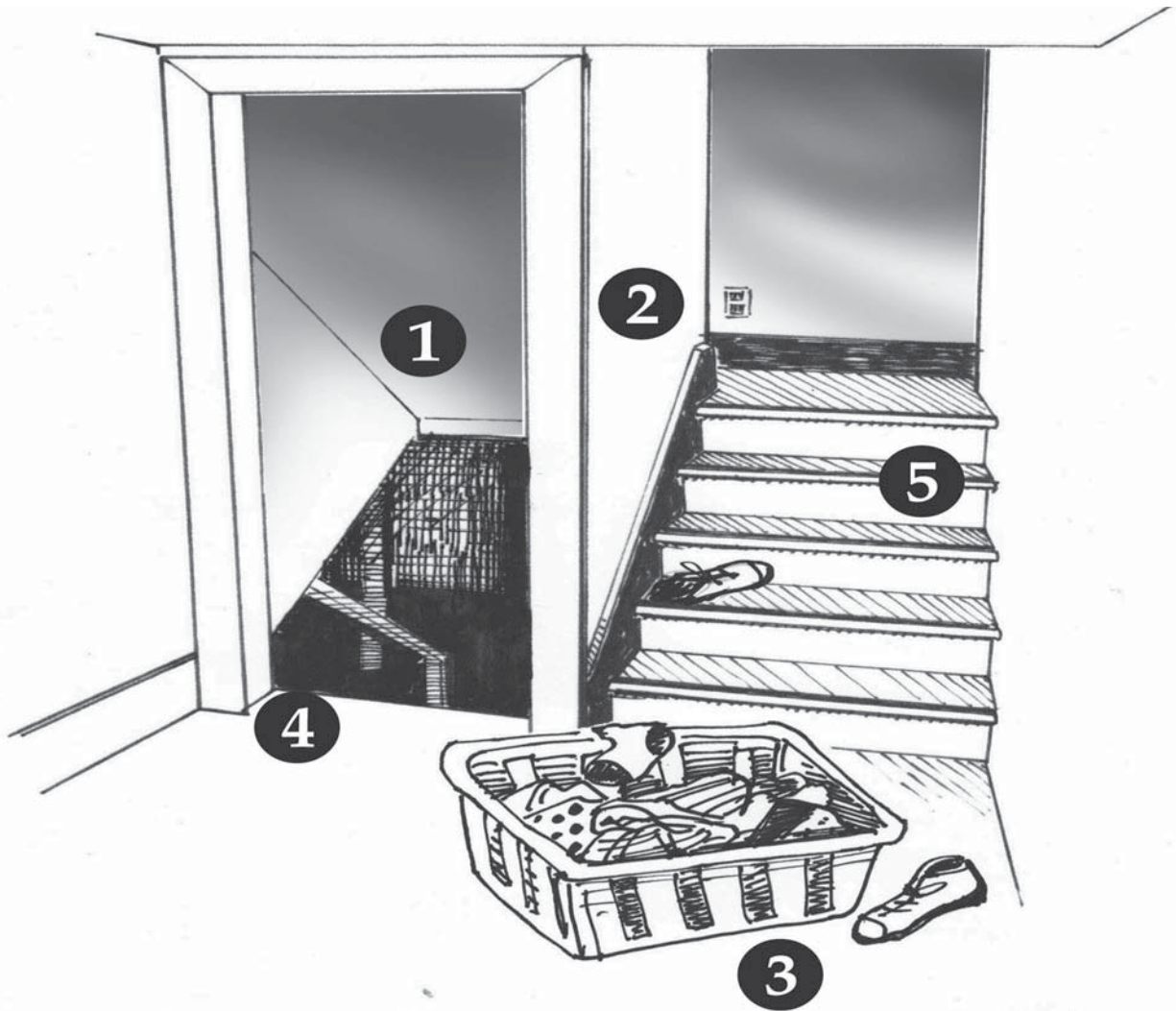

The list identifies all of the potential home hazards that may cause a fall. If the item applies to your home, place a check in the box. Then add the total number of checks and enter it in the box below

1. Lack of or poor lighting

4. Steps too steep

2. Lack of railings

5. Slippery steps without tread/ carpet

3. Clutter

Other \_\_\_\_\_

Total number of problems

\* The numbers correspond to the hazard in the picture and solutions on the following page.



## **Solutions for the Problems** **in Staircases**

### **1. Lack of or poor lighting (See page 29, item 30)**

Increase wattage to allowable limits in lights.  
Add additional overhead or wall lighting.

### **2. Lack of railings (See page 28 & 29, items 27 & 28)**

Add at least one railing down the entire length of the wall, ideally one on each side.

### **3. Clutter**

Eliminate clutter on floors by removing and/or organizing items in areas near the stairs.

### **4. Steps too steep**

Use railings for stability.  
Walk slowly up and down stairs with lights on.  
Have others carry heavy or large items up or down the stairs.  
Reduce daily use of stairs to reduce risk of falls.

### **5. Slippery steps without tread or carpet (See page 29, items 29 and 30)**

Add adhesive stair treads or carpet runner.



## Laundry Room/Basement

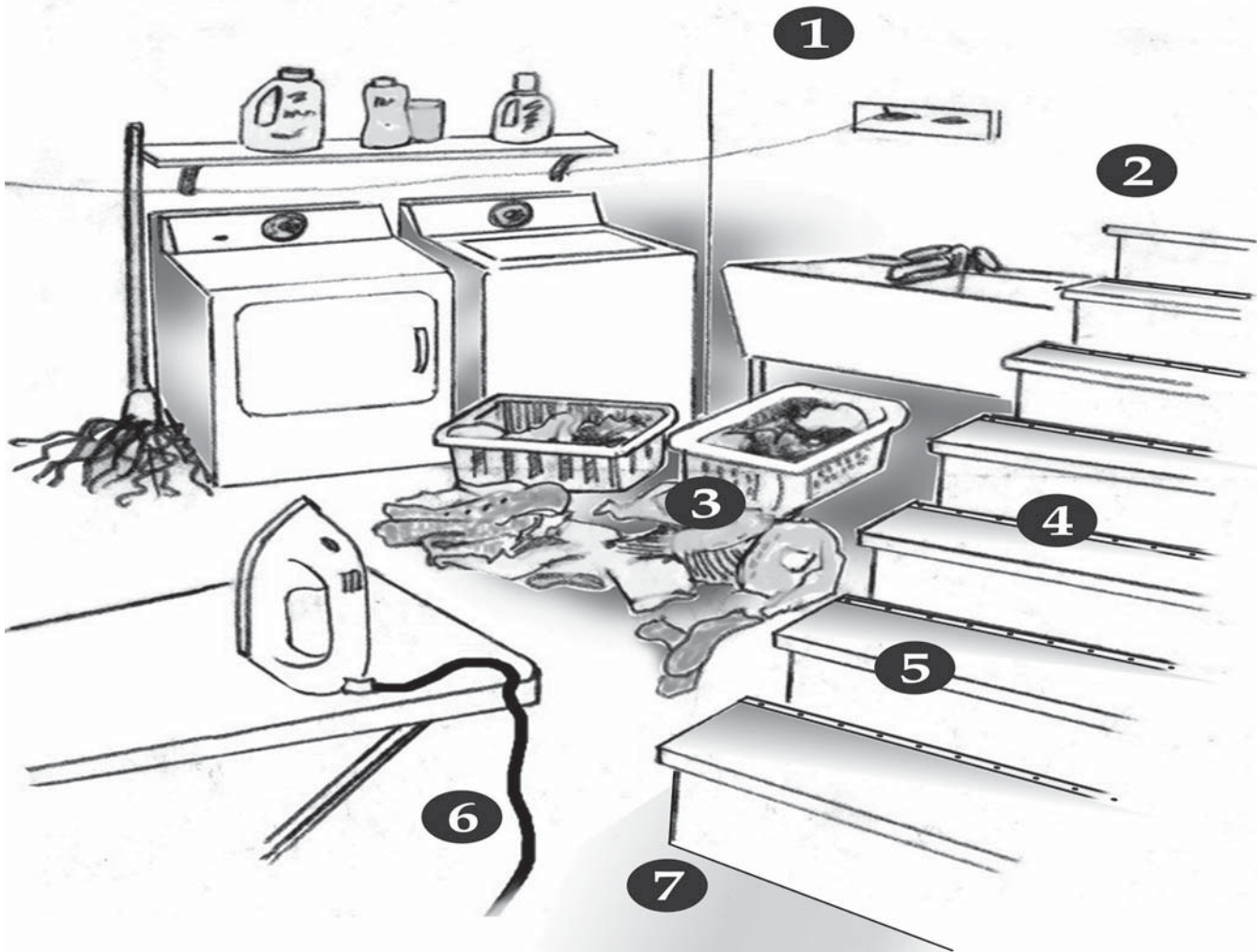

The list identifies all of the potential home hazards that may cause a fall. If the item applies to your home, place a check in the box. Then add the total number of checks and enter it in the box below

- |  |   |
|--|---|
| <input type="checkbox"/> 1. Poor or lack of lighting<br><input type="checkbox"/> 2. Lack of railings<br><input type="checkbox"/> 3. Clutter<br><input type="checkbox"/> 4. Steps too steep | <input type="checkbox"/> 5. Slippery steps without carpet /luminous light<br><input type="checkbox"/> 6. Presence of cords across the floor<br><input type="checkbox"/> 7. Same colored floor at bottom of stairs |
|--|---|

Other \_\_\_\_\_

Total number of problems

\* The numbers correspond to the hazard in the picture and solutions on the following page

## **Solutions for the Problems** **in Laundry Room**

### **1. Lack of or poor lighting**

Increase wattage to allowable limits in lights.  
Add additional overhead or wall lighting.

### **2. Lack of railings**

Add at least one railing down the entire length of the wall, ideally one on each side.

### **3. Clutter**

Eliminate clutter on floors by removing and/or organizing items in areas near the stairs.

### **4. Steps too steep**

Use railings for stability.  
Walk slowly up and down stairs with lights on.  
Have others carry heavy or large items up or down the stairs.  
Reduce daily use of stairs to reduce risk of falls.

### **5. Slippery steps without tread or carpet or luminous light (See page 29, item 30)**

Add adhesive stair treads or carpet runner.

### **6. Presence of cords across the floor (See page 24, item 9)**

Run cords behind furnishings. Use extension cords to accomplish this.  
Rearrange items that must be plugged in to areas near an outlet.

### **7. Same colored floor at bottom of stairs**

Have the bottom of the stairs painted a different color so that you are aware of the last step.

# **Assistive Devices and Helpful Products to Prevent Falls**

## **Disclaimer**

The products listed in this section are currently available on the market. We selected these new types of products based on our experience and public reviews.

For further information, contact the product's manufacturer and distributors. Some local home improvement centers may carry these products. The price ranges listed are as of March, 2011 and are subject to change. For installation of grab bars, railings, and other products, contact qualified professionals for installation. The number before each product (such as **1.** for Vinyl railings) coincides with that in the Picture Credits. (Pages 31-32)

## **Entrance to Front and Back**

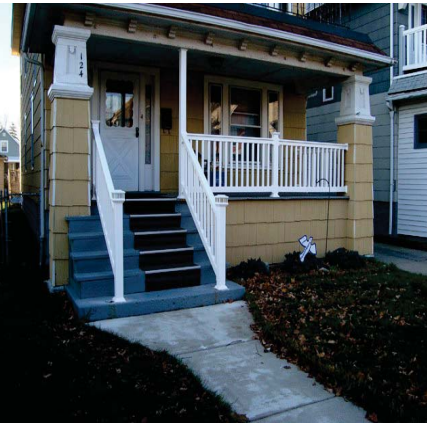

### **1. Vinyl railing**

Hand railings on both sides of the stairs will provide support for safely climbing and descending the stairs. Vinyl railings have advantages over wooden or metallic railings in terms of durability, maintenance costs, corrosion, resistance to mold, and decay.

Price range: Approx. \$68 for 36in X 4ft section

Approx. \$210 for 42in X 8ft section



### **2. Rubber threshold ramp**

Threshold ramps can prevent stumbling and also provide accessibility to the users of a wheelchair or scooter. Rubber threshold ramps have advantages over metallic or wooden ramps in terms of traction and shock absorption. It can be trimmed to custom fit various doorways. It is available in various sizes. (Note: Threshold ramps may be needed for both sides of a threshold)

Price range: Approx. \$90 for 42"(W) X 24"(L) X 1.5"(H)

Approx. \$150 for 42"(W) X 24"(L) X 2.5"(H)



### **3. Motion sensing security lamp**

Lights with motion sensors can detect movement within a specified range and then illuminate. The motion sensing security lamp shown in the picture has a manual override feature so that the light turns on in the dark and turns itself off during the day instead of just when there is motion.

Price range: \$35 – \$70



#### 4. Suitcase/Fold ramp

Suitcase or fold ramps are easy to carry and used to bridge the gap over steps, curbs, and raised landings. To get in and out of mini vans with an end or side entrance, a fold aluminum ramp can be used.

The fold aluminum ramp with non-skid surface shown in the picture has several advantages over wooden and single-piece design ramps because it is corrosion and rust free, has a high traction surface with side rails, and a foldable design for easy transportation.

Price range: \$115 for 2ft ramp  
\$279 for 6ft ramp



#### 5. Cane icetip

An ice tip is easily attached to most canes and crutches to provide good grip on an icy surface. The key feature of the attachment shown in the picture is that it has five prongs to provide greater grip than attachments with one prong, and it can be used with any type of cane.

Price range: \$6 - \$29



#### 6. Outdoor grab bar

A grab bar at an entrance provides support and makes it safer and easier to open an entrance door. The key feature of the plastic grab bar shown in the picture is that it is rust proof and in winter will not get as cold as a metal grab bar. Weight capacity of a recommended grab bar is generally 250 pounds and above.

Price range: \$15 - \$53

## Hallway and Living Room

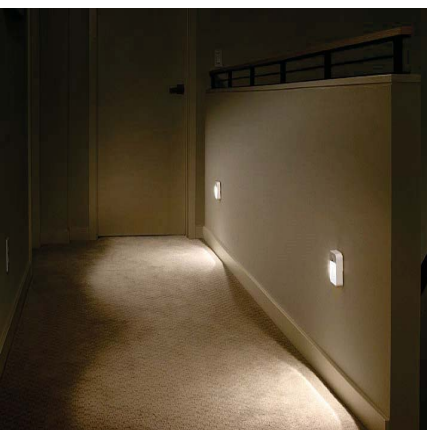

#### 7. Motion sensing LED light

Using automatic LED lights is an efficient way to illuminate dark hallways. The motion sensors activate the light whenever movement is detected, and the auto shut-off feature turns the light off when there is no movement for a preset duration of time. The light in the picture does not require wiring for the installation, and the built-in photocell activates light in a low-glow mode in darkness, thus saving on the battery.

Price range: \$8 - \$40





### 8. Rug pad and double-sided carpet tape

Rug pads can prevent mats and rugs from sliding over the floor and provides cushioning underfoot. Various pads differ in their dimensions, color, and material. Carpet tapes can also be used alone or in combination with a rug pad. The key feature of this rug pad is that it is made from eco-friendly materials.

Price range: \$7 - \$149

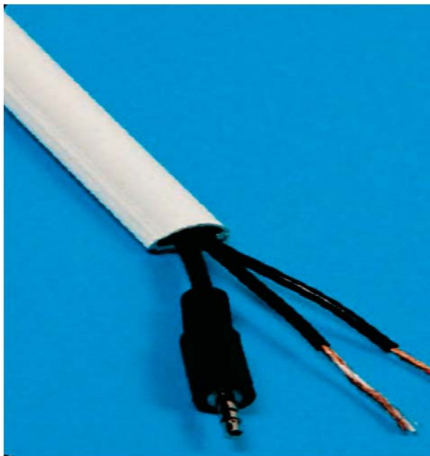

### 9. Single-piece cable cover

Cable covers keep the wires and cords off the floor and eliminate the risk of falls by getting tangled in them. Cable covers such as shown in the picture are easy to install because of their single-piece design and self-adhesive backing. They can also be painted to match the color of the interior.

Price range: \$12 - \$34



### 10. Furniture risers

Risers elevate the height of the bed, chairs, or table if they are too low. They also create considerable space under the bed for storage. The key feature of this furniture leg riser is that it is made of durable polycarbonate with interlocking design for safe stacking, and it can fit most leg types, including castors. The usual weight carrying capacity of a single riser is 600 lb. per leg.

Price range: \$7 - \$49



### 11. Standing cane with tray feature

A standing cane provides safety and balance while getting in or out of a chair. There are several key features of this standing cane such as a fully adjustable height and length, and it features a handy multi-use swivel laptop/TV tray with cup holder and utensil compartment.

Price range: \$130 - \$180

## Kitchen



### 12. Three step ladder

A 3-step ladder with wide platform top is helpful to reach shelves. The ladder shown in the picture has several key features such as a large standing platform for stable and secure use, a thin design for saving storage space, a convenient hand grip with non-skid steps, and non-marring feet for secure footing on the ladder.

Price range: \$28 - \$153



### 13. Non-slip socks/Safe shoes

Well fit canvas shoes or athletic shoes are recommended. Shoes with more than 1.5 inch heels may cause falls. If shoes are not preferred inside the home, then wearing non-slip socks can diminish the risk of falling on bathroom, kitchen, wood and other slippery floors..

The key feature of this non-slip sock is that it has skid resistant treads. Price range: \$2 - \$19 for non-slip socks

\$30 - \$60 for canvas shoes

\$30 - \$70 for athletic shoes



### 14. Lazy Susan

Lazy Susans can be used to save space and organize items in the kitchen. There are many shapes of Lazy Susans such as full circle, kidney shaped, and d-shaped. They can be a single tray or multi-tier shelves. They can be freestanding on a tabletop or installed in a kitchen cabinet. When installing in a cabinet, there should be appropriate clearance from the hinge and door.

Price range: \$8 - \$44 for single turntable

\$50 - \$300 for 2 tier shelf



### 15. Hallway security gate

Security gates of different shapes and sizes are available to keep children and pets away from the kitchen, or other restricted areas of the house. Some of the gates swing open in both directions with easy one hand operation. Some of the gates are tall (39.4 inches) and can expand up to 63.5 inches. (Note: When the door is open, there is still a portion of the gate on the bottom, that remains in the way. Be careful while stepping over the remaining part of the gate.)

Price range: \$55 - \$124





### 16. Programmable stove shutdown device

Automatic stove control devices turn off the stove if a person leaves the kitchen unattended and forgets to come back. The key feature of the device in the picture is that it automatically turns the stove off when someone is not present in the kitchen. It has a motion sensor to detect the presence of an individual in the kitchen. (Note: Different models are available for either 3 or 4 prong stoves).

Price Range: \$296 - \$360

## Bedroom

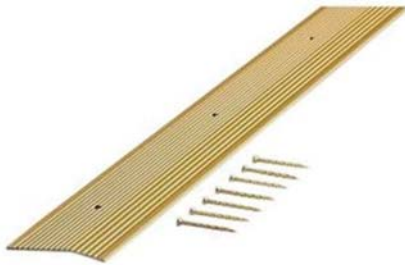

### 17. Carpet trim

Carpet trims are available in different colors and materials such as metal, rubber, wood or plastic. They prevent the carpet edges from fraying and smooth the transition between a floor and a carpet and vice versa. The product shown in the picture has a fluted design for better traction and predrilled holes for easy installation.

Price range: \$4 - \$106 for approximately 2" X 72"



### 18. DECT 6.0 cordless phone

Some of the latest cordless phones offer Digital Enhanced Cordless Telecommunications (DECT) 6.0 technology that provides clearer and louder voice output that can benefit individuals with mild to moderate hearing loss. The key features of this phone are large high contrast and easy to press numbers, an intercom between handsets, sound amplification up to 30 decibels, digital answering machine, and a long battery life. Price range: \$37 - \$192



### 19. Big button remote control

Remote controls for TV and VCR with a small number of buttons are simple to use. The key features of this remote control is that it only has 6 large lighted buttons for the most basic functions and is easy to hold in your hand. Price range: \$14 - \$44



## 20. Bedside cane/bed rail

Bed side canes/bed rails provide assistance for getting in and out of bed. A long bed rail is not recommended because it can cause injuries. The device shown in the picture has the following features: an ergonomic non-slip handle, adjustable height, foldable design for easy storage and travel, an organizing pouch for essential items such as a remote control or a cordless phone, a collapsible design to get it out of the way when required, and safety strap for securing the base of the cane to the bed.

Price range: \$40 - \$160

## Bathroom



## 21. Bathtub grab bar

Some grab bars can be mounted on the edge of the bathtub by a clamping mechanism. The turning knob located on the outside of the clamping mechanism is used to secure the grab bar. The key feature of this grab bar is that it is made of plastic and stainless steel. (Note: Do not use with fiberglass bathtubs because it can damage the fiberglass).

Price range: \$22 - \$171



## 22. Right (90<sup>0</sup>) angled grab bar

Right angled grab bars are used both horizontally and vertically. These grab bars offer a left hand or right hand orientation depending upon the handedness of the user and the placement of the bathtub, shower, or toilet. The grab bar shown in the picture is ADA standards compatible with a non-slip surface. (Note: ADA guidelines say that the clearance between the grab bar and the wall should not be more than 1½").

Price range: \$81 - \$128



## 23. Raised toilet seat

Raised toilet seats assist people with bending and seating difficulties and performing toilet transfers with ease. Features of the device shown in the picture are an extra wide toilet seat for bariatric patients, height adjustable aluminum legs, padded armrests, and, a 600 pounds weight capacity.

Price range: \$13 - \$70 for raised toilet seat without arms

\$30 - \$103 for raised toilet seat with arms

\$75 - \$200 for bariatric raised toilet seat with arms



#### 24. Bath mat

Bath mats will reduce the risk of slipping on a wet bathtub surface. The key features of this mat are use of antimicrobial materials to prevent mold and mildew, machine washable, and suction cups on the bottom. (Note: The mat should be removed from the tub, rinsed, and allowed to air dry after each use).

Price range: \$6 - \$69



#### 25. Water alarm with temperature monitor

Water alarm devices send an audible alarm when the water reaches the base of the unit, to prevent the overflow of water. The key features of the device are: having both a water alarm and temperature monitor within one unit and temperature display on the LCD screen that alerts the user if the water is too hot.

Price range: \$16 - \$17



#### 26. Walk-in bathtub

Walk-in bathtubs offer a swing-in door that allows the user to walk in and out of the bathtub with ease. Some of the walk-in bathtubs also have a seating feature. The swing-in door can either be on the left or right side of the bathtub depending on the orientation of the bathroom. The bathtub shown in the picture has a non-slip bottom surface with arm support inside the tub, and an optional whirlpool system. (Note: Be careful of the elevated step height before getting in or out of the bathtub).

Price range: \$1570 - \$6548

### Staircases and Laundry Room/Basement



#### 27. Stairs grab bar

Specially designed grab bars can be installed on the walls alongside the stairs. The key feature of the grab bar shown in the picture is that its curved design allows for continuous support around the corner of the stairs.

Price range: \$57 - \$166





### 28. Stair railing with a good grip

Stair railings are available in a wide variety of designs, styles and materials. They provide support while climbing or descending the stairs inside the home. They can be made of wood, iron, steel, or vinyl. The design that allows for a good grip, as shown in the picture, is highly recommended instead of handrails that are too fat or wide to comfortably grip.

Price range: \$150 - \$200 for 8 feet section  
\$300 - \$360 for 10 feet section

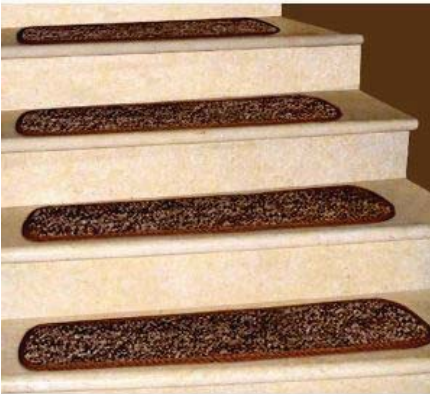

### 29. Stair treads

Stair treads prevent accidental slips while ascending or descending the stairs. They are available in various colors and shapes. The stair treads shown in the picture have skid-resistant rubber backing. These stair treads attach to the surface of the stairs by “hook-and-loop” fastening strips (Velcro). The “hook” strip is sewn into the stair tread and the “loop” strip is glued to the stairs. These strips are used to attach and detach the stair tread when needed.

Price range: \$56 - \$387 for a pack of 12 - 13 pieces.



### 30. Stairs LED lighting kit

When installed on stairs, the motion-activated LED lights illuminate the areas that need additional lighting. The light shown in the picture is battery powered and comes with universal joints (interchangeable joints) that are easy to install.

Price Range: \$50 – \$127

## Personal Emergency Response System and Fall Detecting Device



### 31. Fall detection system

Personal emergency response systems (PERS) detect falls and alert the caregivers, or emergency response call center, or 911 for a monthly fees. These devices use internet or phone lines to send out the alert. The key features of this device are as follows: Tracking the daily activities of a user on a website, automatic fall detection and alert message to family members, automatic reminders if not worn, can be used with compatible cell phone to send alert and fall location.

Price range: \$100 - \$400

## Total Number of Home Hazards

Transfer all the total scores of each room/ area from pages 4-21 to the appropriate boxes and add all the scores to get a grand total. Three blocks for each area are provided for you to keep records of your assessments and improvements for three occasions.

Date	_____	_____	_____
<b>Entrance to Front Door and Front Yard</b>	<input style="width: 50px; height: 25px;" type="text"/>	<input style="width: 50px; height: 25px;" type="text"/>	<input style="width: 50px; height: 25px;" type="text"/>
<b>Entrance to Back/Side Door .....</b>	<input style="width: 50px; height: 25px;" type="text"/>	<input style="width: 50px; height: 25px;" type="text"/>	<input style="width: 50px; height: 25px;" type="text"/>
<b>Hallway or Foyer .....</b>	<input style="width: 50px; height: 25px;" type="text"/>	<input style="width: 50px; height: 25px;" type="text"/>	<input style="width: 50px; height: 25px;" type="text"/>
<b>Living Room .....</b>	<input style="width: 50px; height: 25px;" type="text"/>	<input style="width: 50px; height: 25px;" type="text"/>	<input style="width: 50px; height: 25px;" type="text"/>
<b>Kitchen .....</b>	<input style="width: 50px; height: 25px;" type="text"/>	<input style="width: 50px; height: 25px;" type="text"/>	<input style="width: 50px; height: 25px;" type="text"/>
<b>Bedroom .....</b>	<input style="width: 50px; height: 25px;" type="text"/>	<input style="width: 50px; height: 25px;" type="text"/>	<input style="width: 50px; height: 25px;" type="text"/>
<b>Bathroom .....</b>	<input style="width: 50px; height: 25px;" type="text"/>	<input style="width: 50px; height: 25px;" type="text"/>	<input style="width: 50px; height: 25px;" type="text"/>
<b>Staircases .....</b>	<input style="width: 50px; height: 25px;" type="text"/>	<input style="width: 50px; height: 25px;" type="text"/>	<input style="width: 50px; height: 25px;" type="text"/>
<b>Laundry Room/Basement .....</b>	<input style="width: 50px; height: 25px;" type="text"/>	<input style="width: 50px; height: 25px;" type="text"/>	<input style="width: 50px; height: 25px;" type="text"/>
<b>Grand Total .....</b>	<input style="width: 50px; height: 25px;" type="text"/>	<input style="width: 50px; height: 25px;" type="text"/>	<input style="width: 50px; height: 25px;" type="text"/>

To fix problems at home, you can contact the listed home modification service providers found on pages 35 and 36. To obtain free services for home modification, refer to pages 37 and 38. To record your home modification improvement, use the action log on pages 46 and 47.

## **Picture Credits for Assistive Devices and Helpful Products (as of March, 2011)**

1. Vinyl and resin railing: <http://www.thevinyloutlet.com/railgallery.html>
2. Rubber threshold ramp: <http://www.allegromedical.com/wheelchair-accessories-c545/ez-access-rubber-threshold-ramp-with-beveled-sides-p555797.html>
3. Motion sensing security lamp: [http://www.homedepot.com/h\\_d1/N-5yc1vZ1xhu/R-100125618/h\\_d2/ProductDisplay?langId=-1&storeId=10051&catalogId=10053](http://www.homedepot.com/h_d1/N-5yc1vZ1xhu/R-100125618/h_d2/ProductDisplay?langId=-1&storeId=10051&catalogId=10053)
4. Suitcase ramp for mobility devices: <http://www.allegromedical.com/travel-aids-c6857/ez-access-suitcase-ramps-advantage-series-2-3-4-5-and-6-ft-lengths-p555734.html>
5. Cane icetip: [http://www.amazon.com/Duro-Med-Prong-Grip-Crutch-Attachment/dp/B0009STN2E/ref=cm\\_cr\\_pr\\_pb\\_t](http://www.amazon.com/Duro-Med-Prong-Grip-Crutch-Attachment/dp/B0009STN2E/ref=cm_cr_pr_pb_t)
6. Outdoor grab bar: [http://www.amazon.com/distributed-by-Dynamic-Living-com-Outdoor-Entryway/dp/B001925SLY/ref=sr\\_1\\_13?s=hpc&ie=UTF8&qid=1288965190&sr=1-13](http://www.amazon.com/distributed-by-Dynamic-Living-com-Outdoor-Entryway/dp/B001925SLY/ref=sr_1_13?s=hpc&ie=UTF8&qid=1288965190&sr=1-13)
7. Motion sensing LED light: <http://www.coolstuffcheap.com/mb723.html>
8. Rug pad: [http://www.walmart.com/ip/Eco-Grip-Rug-Saver-Pad/10963059?sourceid=1500000000000003260370&ci\\_src=14110944&ci\\_sku=10963059](http://www.walmart.com/ip/Eco-Grip-Rug-Saver-Pad/10963059?sourceid=1500000000000003260370&ci_src=14110944&ci_sku=10963059)
9. Single-piece cable cover: [http://www.homedepot.com/h\\_d1/N-5yc1vZ1xhu/R-202331945/h\\_d2/ProductDisplay?langId=-1&storeId=10051&catalogId=10053#BVRRWidgetID](http://www.homedepot.com/h_d1/N-5yc1vZ1xhu/R-202331945/h_d2/ProductDisplay?langId=-1&storeId=10051&catalogId=10053#BVRRWidgetID)
10. Furniture Risers: [http://www.amazon.com/Clear-Bed-Risers-Set/dp/B000L3QBKE/ref=pd\\_cp\\_e\\_0](http://www.amazon.com/Clear-Bed-Risers-Set/dp/B000L3QBKE/ref=pd_cp_e_0)
11. Standing cane with tray feature: [http://www.amazon.com/Standers-2052-Able-Tray/dp/B0026IBSUA/ref=pd\\_sim\\_hpc\\_6](http://www.amazon.com/Standers-2052-Able-Tray/dp/B0026IBSUA/ref=pd_sim_hpc_6)
12. Three step ladder: [http://www.amazon.com/Rubbermaid-RM-3W-3-Step-Steel-Stool/dp/B003EYVF7G/ref=sr\\_1\\_3?ie=UTF8&qid=1294332215&sr=8-3](http://www.amazon.com/Rubbermaid-RM-3W-3-Step-Steel-Stool/dp/B003EYVF7G/ref=sr_1_3?ie=UTF8&qid=1294332215&sr=8-3)
13. Non-slip Socks: <http://www.silverts.com/show.cfm/image/19140-non-skidslip-sockshospital-socks/pink>
14. Lazy Susan: <http://www.artfactory.com/wall-lazy-susan-p-3014.html>
15. Tall security gate: <http://www.richelldoggates.info/>
16. Programmable stove shutdown device: <http://www.daily-jeff.com/news/article/4740009>
17. Carpet trim: [http://www.homedepot.com/h\\_d1/N-5yc1vZ1xhu/R-100141363/h\\_d2/ProductDisplay?langId=-1&storeId=10051&catalogId=10053](http://www.homedepot.com/h_d1/N-5yc1vZ1xhu/R-100141363/h_d2/ProductDisplay?langId=-1&storeId=10051&catalogId=10053)



18. DECT 6.0 cordless phone: <http://shop.clarityproducts.com/products/clarity/d613-dect-6-0-loud-cordless-answering-machine-big-button-phone/?cat=dect-6-0-amplified-cordless-phones>
19. Big button remote control: <http://www.amazon.com/Tek-Pal-Button-Remote-Control/dp/B0016RNSHS>
20. Bedside cane: [http://www.amazon.com/Standers-2041-BedCane/dp/B000GUHG6K/ref=sr\\_1\\_1?ie=UTF8&s=hpc&qid=1294338253&sr=8-1-catcorr](http://www.amazon.com/Standers-2041-BedCane/dp/B000GUHG6K/ref=sr_1_1?ie=UTF8&s=hpc&qid=1294338253&sr=8-1-catcorr)
21. Bathtub grab bar: [http://www.amazon.com/Drive-Adjustable-Clamp--Tub-Rail/dp/B001BLTI96/ref=sr\\_1\\_4?ie=UTF8&qid=1294349836&sr=8-4](http://www.amazon.com/Drive-Adjustable-Clamp--Tub-Rail/dp/B001BLTI96/ref=sr_1_4?ie=UTF8&qid=1294349836&sr=8-4)
22. Right angled grab bar: <http://www.shopinpro.com/store/product/tabid/60/p-182-l-shaped-grab-bar.aspx?catid=161>
23. Raised toilet seat: [http://www.amazon.com/Tall-Ette-725881000-Extra-Elevated-Toilet/dp/B000AYG7ZS/ref=sr\\_1\\_8?s=hpc&ie=UTF8&qid=1294348063&sr=1-8](http://www.amazon.com/Tall-Ette-725881000-Extra-Elevated-Toilet/dp/B000AYG7ZS/ref=sr_1_8?s=hpc&ie=UTF8&qid=1294348063&sr=1-8)
24. Bath mat: [http://www.amazon.com/Rubbermaid-18x36-Brown-Bath-Mat/dp/B000VBC1SC/ref=cm\\_cr\\_pr\\_product\\_top](http://www.amazon.com/Rubbermaid-18x36-Brown-Bath-Mat/dp/B000VBC1SC/ref=cm_cr_pr_product_top)
25. Water alarm with temperature monitor: <http://www.amazon.com/Starfish-Warter-Alarm-Temperature-Monitor/dp/B000V22BKY>
26. Walk-in bathtub: <http://www.ameriglide.com/item/AmeriGlide-Sanctuary-Full.html>
27. Stairs grab bar: <http://www.grabbarspecialists.com/products.php?cat=591>
28. Stair railing with a good grip: <http://www.vandykes.com/product/victorian-wooden-handrail>
29. Stair treads: [http://www.amazon.com/12-Attachable-Carpet-Stair-Treads/dp/B0040UIP0I/ref=pd\\_sbs\\_misc\\_15](http://www.amazon.com/12-Attachable-Carpet-Stair-Treads/dp/B0040UIP0I/ref=pd_sbs_misc_15)
30. Stairs LED lighting kit: <http://ecobatteries.net/Motion-Sensor-Stair-and-Hallway-LED/M/B0020MLFQO.htm>
31. Fall detection system: <http://www.wellcore.com/buy/single-user-system/>

## **Tips for Fall Prevention**

- 1. Provide seating at the entrance to the home so that a person can rest or put down things in their hand.**
- 2. Small icicles that are within easy reach should be removed so that entry to and exit from the home are safe. Do not try to remove bigger and dangerous icicles by yourself. Instead have them removed by someone else.**
- 3. Always wear shoes that fit properly, and have nonskid soles with velcro fasteners instead of laces.**
- 4. Install light switches at the top and bottom of all stairs.**
- 5. Use lights with high wattage bulbs to see more clearly.**
- 6. Installation of automatic lighting in the areas of frequent activity can aid in safer night activity.**
- 7. Keep emergency flashlights near the bed to help locate the light switches and provide illumination in case of a power outage.**
- 8. When climbing or descending stairs, you should never be in a hurry to pick up a phone. It can wait!**
- 9. Remember the number of stairs and count each step when climbing or descending the stairs.**
- 10. While carrying things, always keep one hand empty so that it is possible to grab on to something in case support is needed.**
- 11. The electrical and phone cords should be removed from the walkways to reduce the risk of falls.**
- 12. Regularly used items in the kitchen should be placed where they are easily accessible.**
- 13. When using a ladder, always keep three points of contact with the ladder, that is two feet and one hand.**
- 14. The use of a handheld shower makes it safer and easier to take a shower.**
- 15. The size and contents of the laundry basket should not be too heavy. Use a small basket for comfortable use.**
- 16. For emergency purposes there should be a phone in the bathroom, attic, and laundry room.**
- 17. For emergency purposes, a bag with a 3-day supply of water and food, contact list, radio, flash-light, first aid, medications, etc. should be placed near the exit of the house.**

## Home Improvement Centers and Durable Medical Equipment Providers in Erie County

The following durable medical equipment providers in Erie County were selected from the Medical Suppliers listing in the Yellow Pages. (as of March 2011)

<u>NAME AND ADDRESS</u>	<u>TELEPHONE NUMBER E-MAIL ADDRESS</u>
<b>Home Improvement Centers</b>	
The Home Depot <b>Amherst, Buffalo, Cheektowaga, West Seneca, Williamsville</b>	1(800)-466-3337 www.homedepot.com
Lowe's <b>E. Amherst, W. Amherst, Hamburg, Orchard Park</b>	1(800)-445-6937 www.lowes.com
Valu Home Center <b>Amherst, Buffalo, Cheektowaga, Depew, Lackawanna, Orchard Park, Tonawanda, Williamsville</b>	www.valuhomecenters.com
<b>Durable Medical Equipment Providers</b>	
Sheridan Surgical 4513 Bailey Avenue, <b>Amherst</b> , NY 14226	716-836-8780 www.sheridansurgical.com
Cleve-Hill Home Health Care 1479 Kensington Ave, <b>Buffalo</b> , NY 14215	716-832-7744 www.buffalopharmacies.com/home-healthcare/
Dove Medical 4114 Union Road, <b>Cheektowaga</b> , NY 14225-3406	716-688-8911 www.dovemedical.net
Reliant Medical Equipment & Supply 2375 Union Road, <b>Cheektowaga</b> , NY 14227	716-809-1621 www.reliantmedicalequipment.com
Transit Hill Pharmacy 6344 Transit Road, <b>Depew</b> , NY 14043-1095	716-683-9444
Benson's Surgical Supply 1025 Kenmore Ave, <b>Kenmore</b> , NY 14217	716-332-0404 www.bensonsurgical.com
Mobility Plus 1674 Abbot Road, <b>Lackawanna</b> , NY 14218	716-824-2243 www.mobilitypluswny.com
Snyder Health Mart Pharmacy 4536 Main Street, <b>Snyder</b> , NY 14226	716-839-3050
Buffalo Wheelchair 1900 Ridge Road, <b>West Seneca</b> , NY 14224	716-675-6500 www.buffalowheelchair.com
Union Medical Pharmacy 1769 Orchard Park Road, <b>West Seneca</b> , NY 14224	716-675-4133

## Home Modification Service Providers in Erie County

The following service providers were selected from among those who responded to our request to reply to create this list. They are insured, have experience in residential home modification to prevent falls, and are willing to do a job under \$1,000. They have completed the workshop offered by us regarding the Americans with Disabilities Act and issues related to home modifications for fall prevention. (as of March 2011)

<u>NAME AND ADDRESS</u>	<u>TELEPHONE NUMBER</u> <u>EMAIL ADDRESS</u>
Home Accessibility Construction 16 Canterbury Ct, <b>Amherst</b> NY 14226 <b>Specializes in grab bars, railings, shower equipment</b>	716-833-3220 Ext 1
Dennis Voytovich Acemen Services 11 Vincent Ave, <b>Buffalo</b> , NY 14225 <b>Specializes in grab bars, railings, shower equipment</b>	716-472-6094
Empire Renovations 220 Wendel Ave, <b>Buffalo</b> , NY 14223 <b>Specializes in full service and general contracting</b>	716-573-2006 716-693-5251 <a href="http://www.empirerenovations.com">www.empirerenovations.com</a>
Surianello General Concrete Contractors Inc. 635 Wyoming Ave, <b>Buffalo</b> , NY 14215 <b>Specializes in full service and general contracting</b>	716-837-7710 <a href="mailto:surianello@aol.com">surianello@aol.com</a>
Jim Peron Center for Assistive Technology, 18 Kimball Tower University at Buffalo, 3435 Main Street, <b>Buffalo</b> , NY 14214 <b>Specializes in grab bars, railings, shower equipment</b>	716-829-6711 <a href="mailto:jimperon@buffalo.edu">jimperon@buffalo.edu</a>
Munro Products 9150 Clarence Center Road, <b>Clarence Center</b> , NY 14032 <b>Specializes in full service and general contracting</b>	716-741-9450 <a href="http://www.munroproducts.com">www.munroproducts.com</a>
Nolon General Contracting 6769 Tuscany Lane, <b>East Amherst</b> , NY 14051 <b>Specializes in full service and general contracting</b>	716-741-8167 <a href="http://www.NolonContracting.com">www.NolonContracting.com</a>

<p>Dodge Enterprises LLC. 136 Elm St, <b>East Aurora</b>, NY 14052 <b>Specializes in full service and general contracting</b></p>	<p>716-652-4910 652-4961 (Fax) www.dodgeenterprises.com</p>
<p>Richard Lent Lent Builders Inc. 2416 White Haven Rd, <b>Grand Island</b>, NY 14072 <b>Specializes in full service and general contracting</b></p>	<p>716-876-7816 www.lentbuilders.com</p>
<p>Burke Homes 5540 Southwestern Blvd # B, <b>Hamburg</b>, NY 14075 <b>Specializes in full service and general contracting</b></p>	<p>716 646-0047</p>
<p>David J. Palmeri Palmeri Builders Inc. 79 Victoria Blvd, <b>Kenmore</b>, NY 14217 <b>Specializes in full service and general contracting</b></p>	<p>716-873-5418 (Off.) 716-602-8694 (Mob.)</p>
<p>Skubis Brothers Construction 12 Parkside Drive, <b>Lancaster</b>, NY 14086 <b>Specializes in full service and general contracting and concrete work</b></p>	<p>716-683-7232 716-432-6263</p>
<p>Michael Tucker Sharp General Contracting Inc. <b>CAPS provider</b> 558 Oliver St, North <b>Tonawanda</b>, NY 14120 <b>Specializes in full service and general contracting</b></p>	<p>716-743-2050 www.sharpgeneralcontracting.com</p>
<p>Lakestone Development Inc 17 Limestone Rd #2, <b>Williamsville</b>, NY 14221 <b>Specializes in full service and general contracting</b></p>	<p>716-631-1905</p>

## **Organizations That Provide Free Services (as of March 2011)**

### **Center for Assistive Technology (CAT) Client Service**

CAT provides equipment on loan (free of charge) to individuals who can't afford to buy their own. They loan out equipment for about 6 to 8 weeks (that is the usual length of time).

**Address:** WNY Independent Living, Inc. 3108 Main Street, Buffalo, NY 14214

**Contact person:** Kimberly S. Naus

**Phone:** 716-836-1168

**Email:** kshaus@buffalo.edu

**Website:** <http://cat.buffalo.edu/>

### **Erie County Department of Senior Services**

Erie County Senior Services helps people find the best care in the home. They provide funding for minor home repairs and assist with all sorts of other problems.

**Address:** 95 Franklin Street - Room #1329, Buffalo, NY 14202

**Phone:** 716-858-8526

**Email:** seniorinfo@erie.gov

**Website:** <http://www.erie.gov/depts/seniorservices>

### **Lions Blind & Charity Fund, Inc**

Lions Club provides assistive devices such as eyeglasses, hearing aids, etc to citizens in their respective communities, and maintains loan closets for equipment such as wheelchairs and crutches.

**Address:** P.O. Box 2011, Buffalo, NY 14226

**Phone:** 716-694-4710

**Website:** <http://www.buffalolionsclub.org/>

### **Independence Foundation Loan Closet**

Independence Foundation Loan Closet provides services for individuals and families with disabilities. Items that are provided include ramps, wheelchairs, hospital beds, etc. Individuals must arrange for personal pick up of the items.

**Address:** 2220 Hall Road, Elma, NY 14059.

**Contact Person:** Christine Muller

**Phone:** 716-685-3976

**Website:** <http://www.theindependencefoundation.org>

### **Hamburg Loan Closet (American Red Cross Hamburg Loan Closet)**

Hamburg Loan Closet offers medical equipment to members of the community at no cost for a short period of time. The individual is responsible for pickup and return of the equipment. This program is coordinated completely by Red Cross volunteers.

**Address:** 5161 Camp Road, Hamburg NY 14075

**Contact Person:** Ken Walker

**Phone:** 716-648-4400



### **Muscular Dystrophy Association (MDA) of WNY Loan Closet**

MDA loan closets lend durable medical equipment to those unable to obtain prescribed equipment through alternate sources. Depending on availability, the loan closets offer, at no cost, hospital beds, patient lifts, wheelchairs, walkers, shower benches, transfer boards, communication devices and other durable medical equipment to those the Association serves with muscular dystrophy and related neuromuscular diseases.

**Address:** 500 Main Street # 343, Buffalo, NY 14221

**Contact person:** Johnita Hairston (Health Care Services Coordinator)

**Phone:** 716-626-0035

**E-mail :** jhairston@mdausa.org

### **People Inc. Senior Services**

The Access to Home program in People Inc. provides financial assistance with home modifications for seniors and individuals with disabilities in order to prevent movement into a nursing home or other types of assisted living centers.

**Address:** 1219 North Forest Road, P.O. Box 9033, Williamsville, New York 14231

**Phone: (716) 817-9000**

**Website:** [http://www.people-inc.org/senior\\_services\\_accesstohome.asp](http://www.people-inc.org/senior_services_accesstohome.asp)

### **Supportive Services Corporation**

Supportive Services Corporation is a private non-profit organization administrating federal, state, and local grants. They provide weatherization assistance to income eligible Erie County residents outside of the City of Buffalo.

**Address:** 245 Elmwood Avenue, Buffalo NY 14222

**Contact Person:** Daniel Wojcik

**Phone: (716) 881-6350**

**Website:** <http://www.supportiveservices.org/>

### **Legal Services for the Elderly, Disabled, or Disadvantaged of WNY (LSED)**

LSED is a not-for-profit human service agency that provides specialized, free civil legal services to elderly people in the community of Western New York. They have a housing program through which they assist clients in obtaining grant money to make necessary home repairs.

**Address:** 237 Main Street, Suite 1015, Buffalo, NY 14203-2717

**Phone: (716) 853-3087 in Erie County**

**Website:** <http://www.lsed.org/contact.php>

### **Neighborhood Legal Services, Inc.**

Neighborhood Legal Services, Inc. is a not-for-profit agency that provides services to persons with low-income and/or disabilities. They enforce the Fair Housing Act to obtain assistive technology and provide services regarding housing.

**Address:** 237 Main Street, 4th floor, Buffalo, NY 14203

**Phone: (716) 847-0650, TTY (716) 847-1322**

**Website:** <http://www.nls.org/nlsbroch.htm>

# **Instruction for Home Modifications to Prevent Falls: ADA Guidelines**

By Dean Carroll OTR/L

Americans with Disabilities Act of 1990 (ADA) established guidelines for wheelchair users and individuals with disabilities in the community. ADA guidelines are designed to meet the needs of the majority of users, no matter what their ability or disability level is. Although it does not specially apply to residential homes, it is important to keep the ADA guidelines in mind when modifying homes for an individual's need.

ADA guidelines have already been proven to be effective for most people. Many homes in Erie County were built prior to 1976 and before the current, more standardized building codes. Those homes were not built for wheelchair use, walker access, and older adults. For these homes, home modification may be necessary using ADA guidelines.

Most commonly needed modifications are:

- bathroom grab bars near the toilet and in the shower or the tub;
- railings on both sides of a stairway, if possible;
- widening of door frames for greater access to common areas such as bathrooms, kitchens, and bedrooms; and
- repair and removal of structural barriers such as inadequate flooring, uneven transitions between flooring surfaces, and other non-structural barriers such as furniture.

Structural issues and barriers to meeting ADA guidelines are:

- limited floor space,
- limited wall space for installing grab bars,
- wall studs that are generally 16 inches on center,
- unknown barriers within walls, and
- financial limitations.

Common devices and features for consideration are:

- smooth versus textured grab bars,
- one stair railing versus two stair railings,
- height of grab bars in comparison to the user, and
- minimum width of door frames for walker and wheelchair access.

The following pages are figures for: toilet grab bars, shower access, grab bar spacing, wheelchair ramps, and wheelchair turning space from Department of Justice, Code of Federal Regulations, ADA Standards for Accessible Design and they are available from <http://www.ada.gov/adastd94.pdf>.

# Toilet Grab Bars

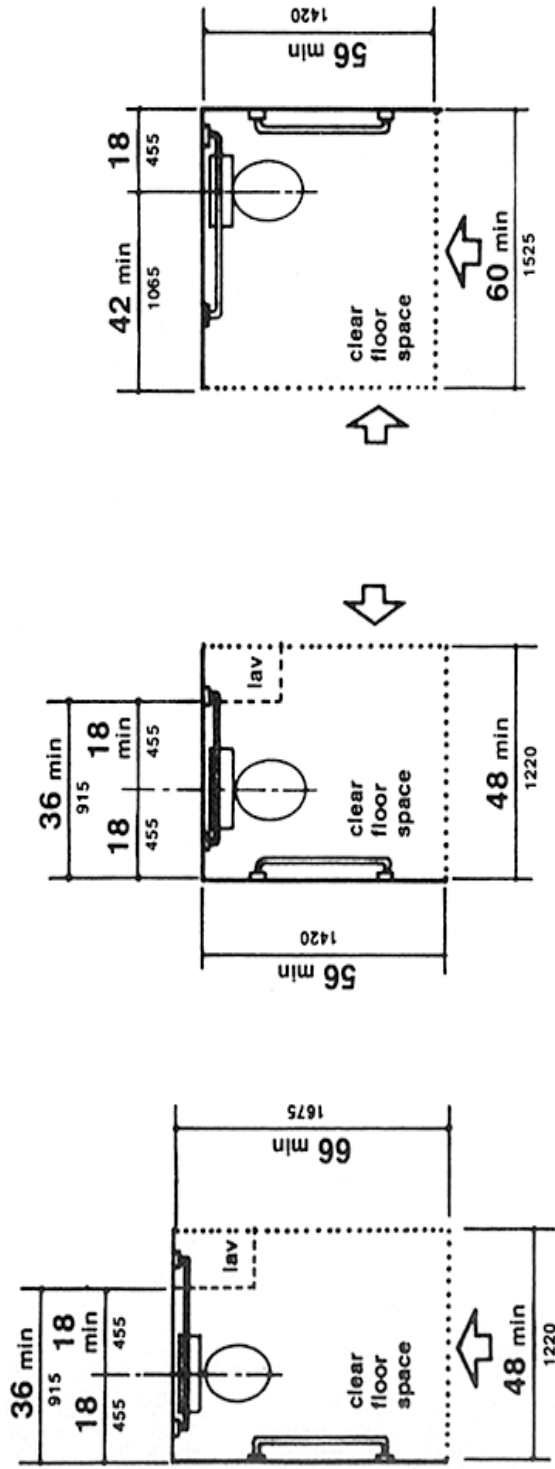
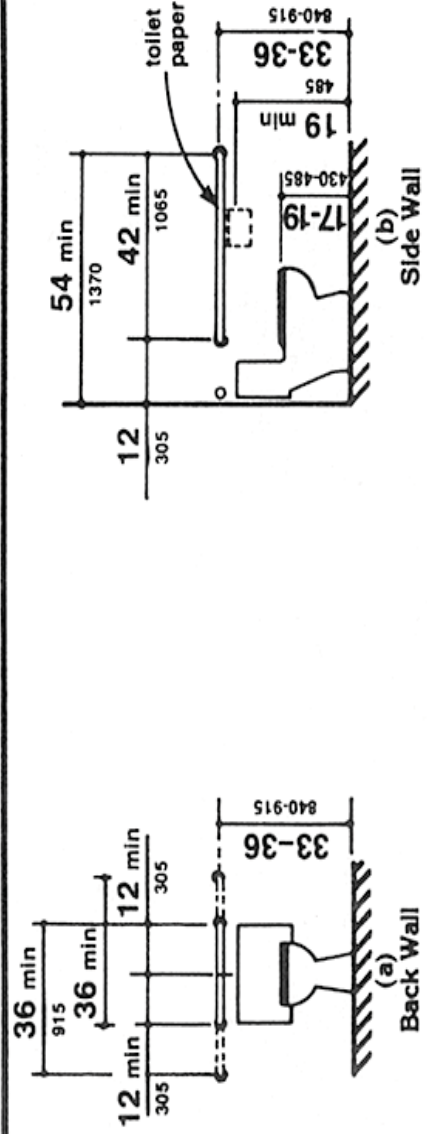
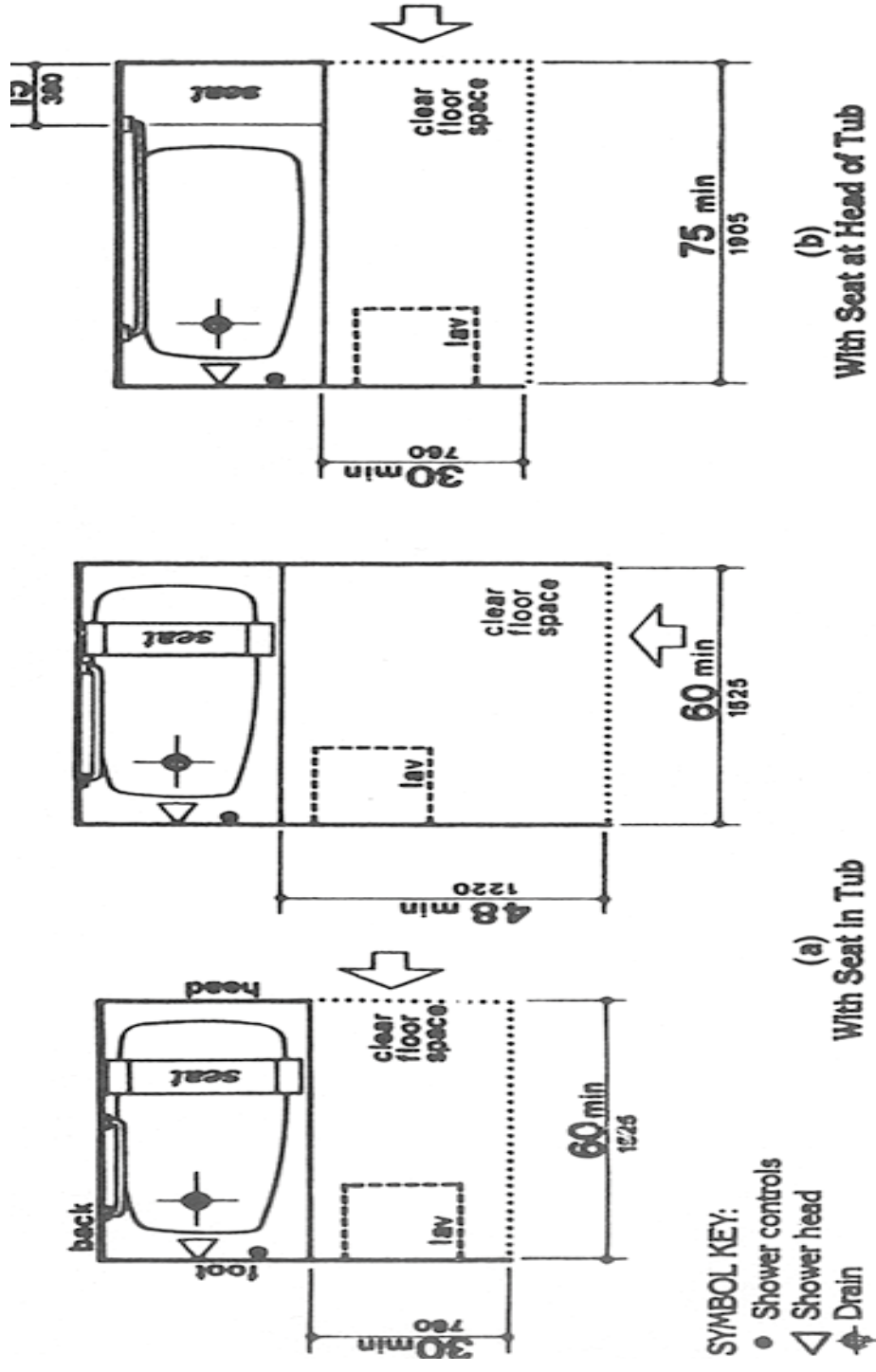

Fig. 28  
Clear Floor Space at Water Closets



# Shower Access



**Fig. 33**  
Clear Floor Space at Bathtubs



# Grab Bar Spacing

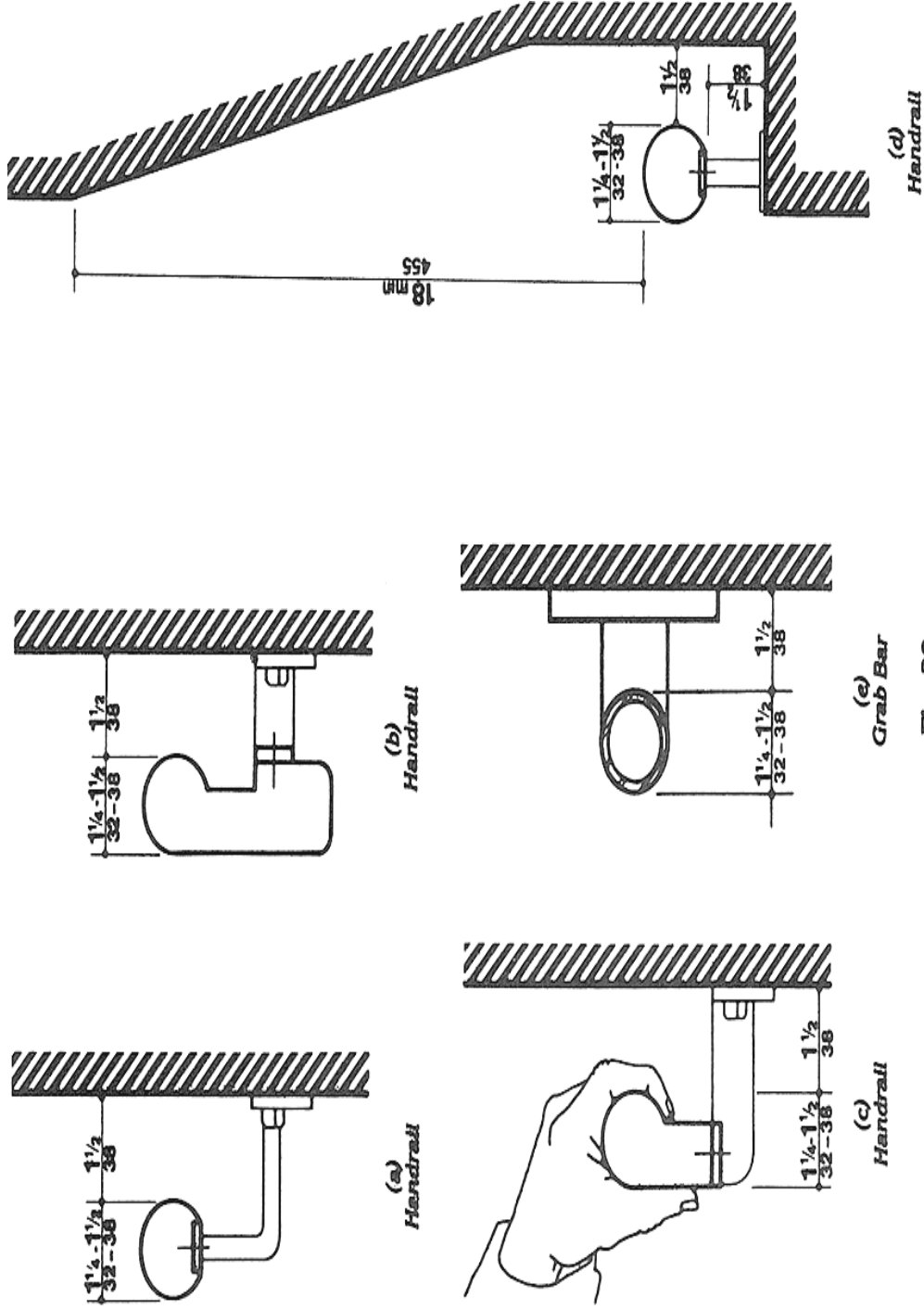
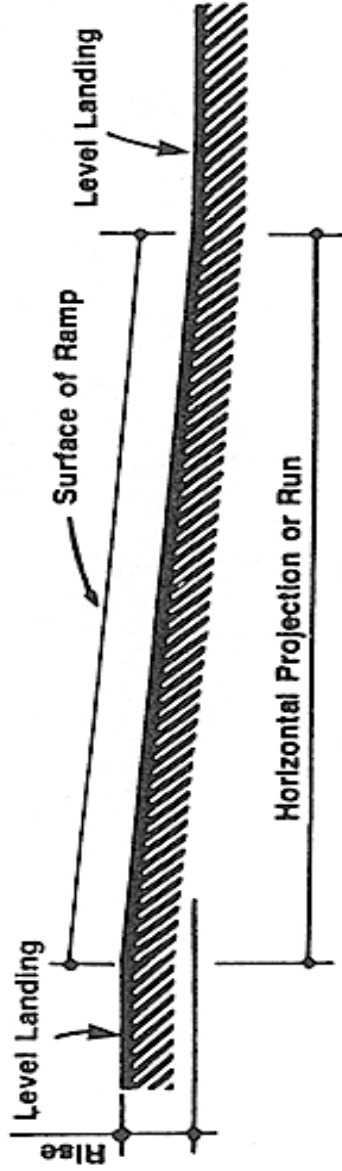

**Fig. 39**  
Size and Spacing of Handrails and Grab Bars

Department of Justice, Code of Federal Regulations, ADA Standards for Accessible Design, 1994, p. 542



# Wheelchair Ramps



Maximum Rise		Maximum Horizontal Projection	
Slope	in	mm	ft
1:12 to < 1:16	30	760	30
1:16 to < 1:20	30	760	40

**Fig. 16**  
**Components of a Single Ramp Run and Sample Ramp Dimensions**

# Wheelchair Turning Space

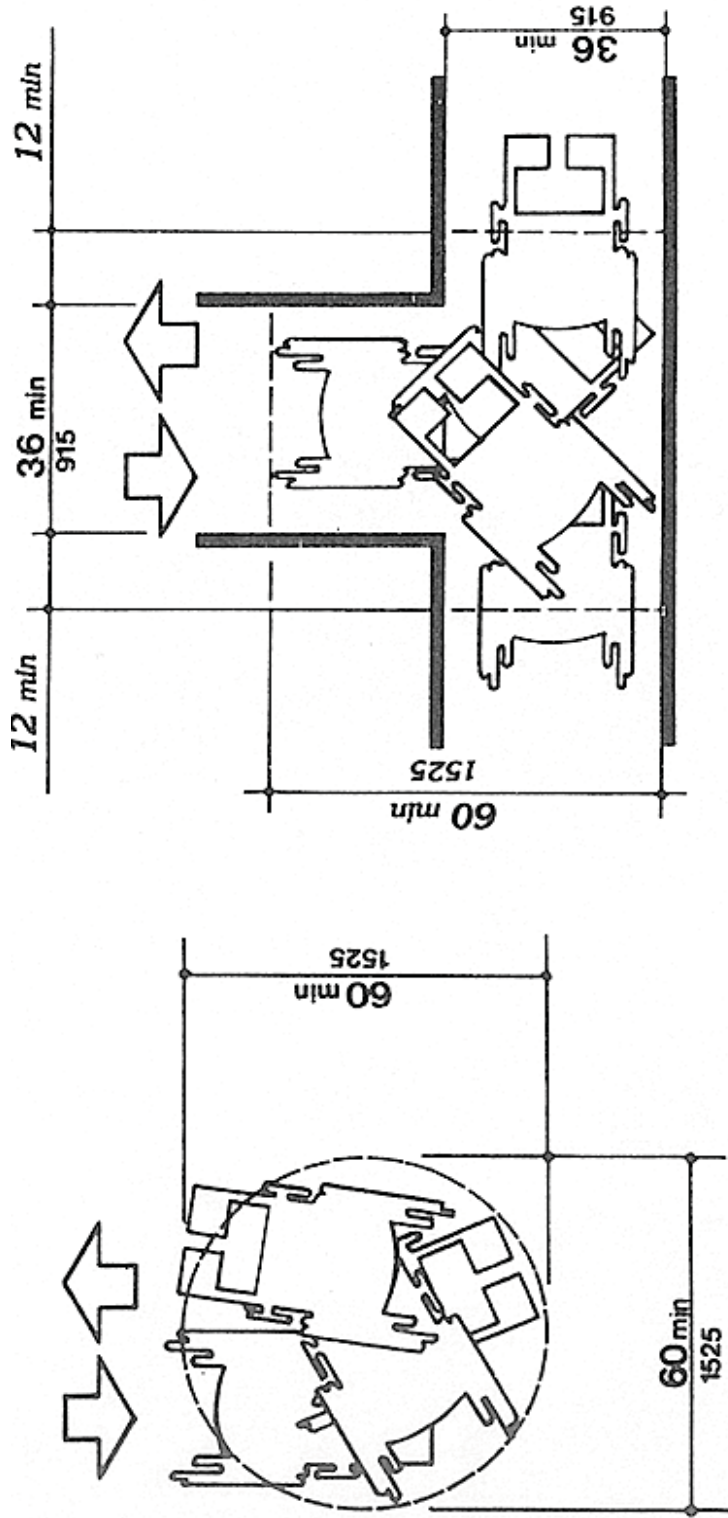

(a) 60-in (1525-mm)-Diameter Space

(b) T-Shaped Space for 180° Turns

Fig. 3  
Wheelchair Turning Space

Department of Justice, Code of Federal Regulations, ADA Standards for Accessible Design, 1994, p. 507

**ACTION LOG:**  
**ACTION TAKEN TO PREVENT FALLS AT MY HOME**

The Problem/Hazard:	I will do:	I have done: (mm/dd/yyyy)	Resources used/Cost
<u>1.</u>			
<u>2.</u>			
<u>3.</u>			
<u>4.</u>			
<u>5.</u>			
<u>6.</u>			
<u>7.</u>			

**ACTION LOG:**  
**ACTION TAKEN TO PREVENT FALLS AT MY HOME**

The Problem/Hazard:	I will do:	I have done: (mm/dd/yyyy)	Reduces used/cost
<u>8.</u>			
<u>9.</u>			
<u>10.</u>			
<u>11.</u>			
<u>12.</u>			
<u>13.</u>			
<u>14.</u>			

## Acknowledgements

John A. Nyquist, MS, CMI  
Board Certified Medical Illustrator  
Office of the VP for Health Sciences, UB

Dean J. Carroll, OTR/L  
President, Home Accessibility Consultation

Michael Noe, MD, MPH  
Associate Dean, Community Relations and Clinical Affairs,  
School of Public Health and Health Professions, UB

Michael Anton Sciortino, JD, MS  
Programmer/Analyst (Project), School of Public Health and Health Professions

---

### **OT Geriatric Group, Department of Rehabilitation Science, UB**

Machiko R. Tomita, Ph.D.

Susan Nochajski, Ph.D., OTR/L

Jo Schweitzer, OTR/L, MS

James A. Lenker, Ph.D., OTR/L

Linda S. Russ, Ph.D., OTR/L,

Sheela Rajendran, OTR/L, MS,

Sumandeep Saharan, OT

---

For download of this material, visit

**[www.agingresearch.buffalo.edu](http://www.agingresearch.buffalo.edu)**

For questions, suggestions, and requests related to this material,  
contact:

Machiko R. Tomita, Ph.D.  
Phone: (716) 829-6740  
Email: [machikot@buffalo.edu](mailto:machikot@buffalo.edu)  
Department of Rehabilitation Science  
University at Buffalo  
631 Kimball Tower  
Buffalo, New York 14214



## **Acknowledgements**

(In alphabetical order)

### **Autumnwood Senior Center**

1800 Clinton St. Buffalo, NY 14206  
(716) 826-7895

### **Erie County Department of Senior Services**

95 Franklin Street, Room 1329, Buffalo, NY 14202  
(716) 858-8526

[http://www.erie.gov/depts/seniorservices/services\\_guide.asp](http://www.erie.gov/depts/seniorservices/services_guide.asp)

### **Gloria J. Parks Community Center**

3242 Main Street, Buffalo, NY 14214  
(716) 832-1010  
<http://uhcda.org/web/>

### **Meals on Wheels for Western New York**

100 James E Casey Drive, Buffalo, NY 14206  
(716) 822-2002  
<http://www.mealsonwheelswny.org/>

### **Millard Fillmore Suburban Hospital**

1540 Maple Road, Williamsville, NY 14221  
(716) 569-3600  
<http://suburban.kaleidahealth.org/>

### **Network in Aging of Western New York**

505 Kimball Tower, University at Buffalo  
3435 Main Street, Buffalo, NY 14214  
(716) 829-3712  
<http://www.networkinaging.com/>

### **Parkside Community Association, Flint Hill Village Program**

2318 Main Street, Buffalo, NY 14214  
(716) 838-1240  
<http://www.parksidebuffalo.org/>

### **Visiting Nursing Association of Western New York**

2100 Wehrle Drive, Buffalo, NY 14221  
(716) 630-8750  
<http://www.vna-wny.org/index.asp>  
[seniorinfo@erie.gov](mailto:seniorinfo@erie.gov)

# HSSAT v.3



**Occupational Therapy Geriatric Group  
Department of Rehabilitation Science  
School of Public Health and Health Professions  
University at Buffalo**

**FallsPrevention™**  
STEP UP TO STOP FALLS

Supported by a grant from the Community Health Foundation of Western and Central New York